

Schoolsrus

School Furniture Catalogue 2024/25



0845 6033 606



www.schoolsrus.co.uk



Welcome to Schoolsrus

We are an educational furniture company committed to supplying schools with **high quality** furniture at the **lowest** prices.



Reasons to choose Schoolsrus

- ✓ **30 Years Experience** in the educational furniture industry
- ✓ **Lowest Online Prices** - why pay more?
- ✓ **New Build? No Problem** - fantastic project management skills
- ✓ **Unrivalled Customer Service** - we are honest and reliable
- ✓ **We're Available 24/7** via an emergency number provided

How do I place my order?

Ordering from us couldn't be simpler.
We accept orders via telephone, our website or by email.

All schools are entitled to 30 days credit.

Delivery is free on orders over £345.00 plus VAT (or £30.00 below)



Hille ErgoStak Chairs

Eco friendly, ergonomic and fantastic value for money

Brand new to the classroom chair market - the Hille Ergostak Chair.

An eco-friendly, ergonomic one piece chair - the only one piece chair to be built completely in-house in Britain.

ErgoStak is tough and durable and has been tested up to 158kg (nearly 25 stone) of user weight.

It has unbeatable strength and a 25 year guarantee.

ErgoStak is an eco-friendly option. This chair has the lowest possible carbon footprint due to being made in Britain and is fully recyclable.

Available in sizes 5 and 6 only.

Stacks 10 high when not in use.

25
YEARS
Guarantee



Free samples available
on request

Order Code	Seat Height	1-99	100+
SRS-2401	430mm	£21.50	£20.50
SRS-2402	460mm	£22.25	£21.25

Not sure what size? Turn to page 2 for our size guide.

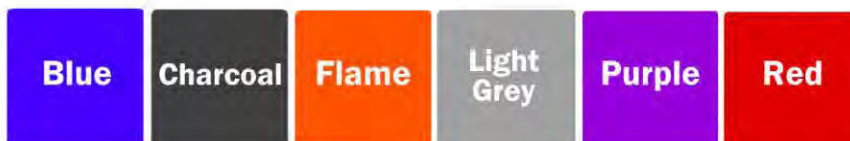

0845 6033 606



sales@schoolsrus.co.uk

3

Postura Plus Chairs

The UK's most popular One Piece Chair at the lowest prices

We are proud to be one of the UK's leading suppliers of Postura Plus Chairs.

Save money for your school by choosing Schoolsrus.

Hazy Jade



Light Sand



Rose Blossom



20
YEARS
Guarantee

Best
Seller

Brand New for 2024 - Postura Plus Chairs are now available in a range of 20 colours, including a number of pastel shades.



Postura Plus Chairs

The UK's most popular One Piece Chair at the lowest prices

The Postura Plus Chair is proven to be durable, comfortable and offer excellent value for money.

Made in the UK from high impact resistant polypropylene, their gas injected legs increase strength and reduce weight.

Available in a range of vibrant colours, they are strong, light, stain resistant, antistatic and easy to clean.



Order Code	Seat Height	1-19	20-199	200+
SRS-002	310mm	£22.50	£20.50	£20.00
SRS-003	350mm	£23.20	£21.20	£20.70
SRS-004	380mm	£23.55	£21.55	£21.05
SRS-005	430mm	£26.40	£24.40	£23.90
SRS-006	460mm	£27.90	£25.90	£25.40

Not sure what size? Turn to page 2 for our size guide.



These chairs now contain at least 50% recycled polypropylene. This is a major milestone on KI's journey towards 100% recycled content.



0845 6033 606



sales@schoolsrus.co.uk

5

Titan One Piece Chairs

Strong, ergonomic and offering fantastic value for money

20
YEARS
Guarantee

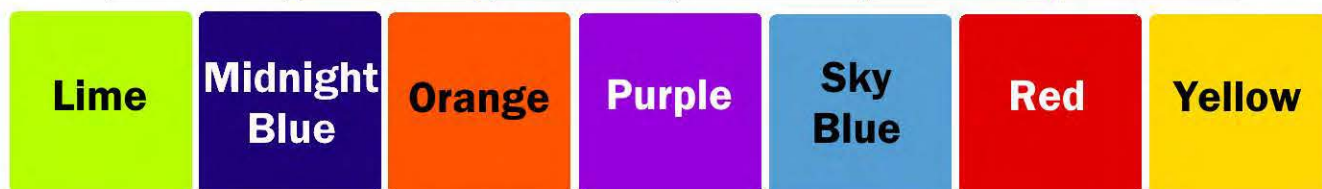

Titan One Piece Chairs

Strong, ergonomic and offering fantastic value for money

Titan One Piece Chairs are an incredibly popular choice of classroom chair offering great value for money.

These chairs are ultra-strong, tamperproof and feature an ergonomic build with anti-tilt legs.

Its continuous one piece shell ensures there are no pinch points or sharp edges to cause injury.

EN1729 certified for strength and stability.

Stacks 15 high for easy storing.



Order Code	Seat Height	1-19	20-199	200+
SRS-012	310mm	£19.20	£18.85	£18.50
SRS-013	350mm	£20.10	£19.75	£19.40
SRS-014	380mm	£20.85	£20.50	£20.15
SRS-015	430mm	£23.60	£23.25	£22.90
SRS-016	460mm	£24.35	£24.00	£23.65



Not sure what size? Turn to page 2 for our size guide.

Additional Extras	Price
SRS-025 Seat Pad Surcharge	£17.00
SRS-027 Titan Chair Trolley	£160.00



0845 6033 606



sales@schoolsrus.co.uk

7

EN One Chairs

Combining perfect posture with optimum comfort



21
YEARS
Guarantee

The EN One Chair features a modern, streamline design that offers fantastic ergonomics, providing all day comfort and flexibility.

A waterfall front helps to improve circulation whilst sitting and the angled rear legs discourage tilting.

Stacks 21 high within a 2 metre space.

Order Code	Seat Height	1-29	30-199	200+
SRS-2001	310mm	£18.00	£17.50	£17.00
SRS-2002	350mm	£19.50	£19.00	£18.50
SRS-2003	380mm	£21.50	£21.00	£20.50
SRS-2004	430mm	£24.50	£24.00	£23.50
SRS-2005	460mm	£25.50	£25.00	£24.50

Not sure what size? Turn to page 2 for our size guide.



Harmony and Masterstack

Popular classroom chairs

Harmony Stacking Chairs

This vertical stacking chair conforms to EN1729 Part 2 for strength and stability.

Black, Light Grey or Anthracite frames.

Order Code	Seat Height	1-29	30-199	200+
SRS-040	310mm	£27.75	£27.25	£26.75
SRS-041	350mm	£28.25	£27.75	£27.25
SRS-042	380mm	£28.30	£27.80	£27.30
SRS-043	430mm	£28.65	£28.15	£27.65
SRS-044	460mm	£29.05	£28.55	£28.05

Not sure what size? Turn to page 2 for our guide.



Masterstack Chairs

Super strong and recommend for severe contract use.

Skidbase frame protects flooring.

Black, Light Grey or Anthracite frames.

Order Code	Seat Height	1-29	30-199	200+
SRS-052	310mm	£28.35	£27.85	£27.35
SRS-053	350mm	£28.75	£28.25	£27.75
SRS-054	380mm	£28.85	£28.35	£27.85
SRS-055	430mm	£29.25	£28.75	£28.25
SRS-056	460mm	£29.65	£29.15	£28.65



0845 6033 606



sales@schoolsrus.co.uk

Titan Classroom Chairs

Designed to withstand heavy duty, every day usage

Titan 4 Leg Classroom Chairs

The Titan 4 Leg Chair is super strong and conforms to EN1729 parts 1 and 2.

Impact resistant polypropylene seat.

Strong steel frames.

Tamperproof fixings.

Order Code	Seat Height	1-29	30-199	200+
SRS-999	310mm	£22.85	£22.35	£21.85
SRS-017	350mm	£23.25	£22.75	£22.25
SRS-018	380mm	£23.75	£23.25	£22.75
SRS-019	430mm	£25.10	£24.60	£24.10
SRS-020	460mm	£25.50	£25.00	£24.50



Titan Skidbase Chairs

Designed to withstand the heavy duty, day to day use in a classroom thanks to its super strong oval tube frame with floor protectors.

Order Code	Seat Height	1-29	30-199	200+
SRS-021	350mm	£25.50	£25.00	£24.50
SRS-022	380mm	£25.85	£25.35	£24.85
SRS-023	430mm	£27.00	£26.50	£26.00
SRS-024	460mm	£27.25	£26.75	£26.25

Both chairs are available in these colours:



Not sure what size? Turn to page 2 for our size guide.

*460mm only



GEO Classroom Chairs

Available in a 4 leg or skidbase version

GEO Chairs are a premium choice of classroom chair.

UK manufactured.

Stackable 8 high.

Strong and stable, certified to BS EN1729 Parts 1 and 2.

Choice of Black or Light Grey frames.

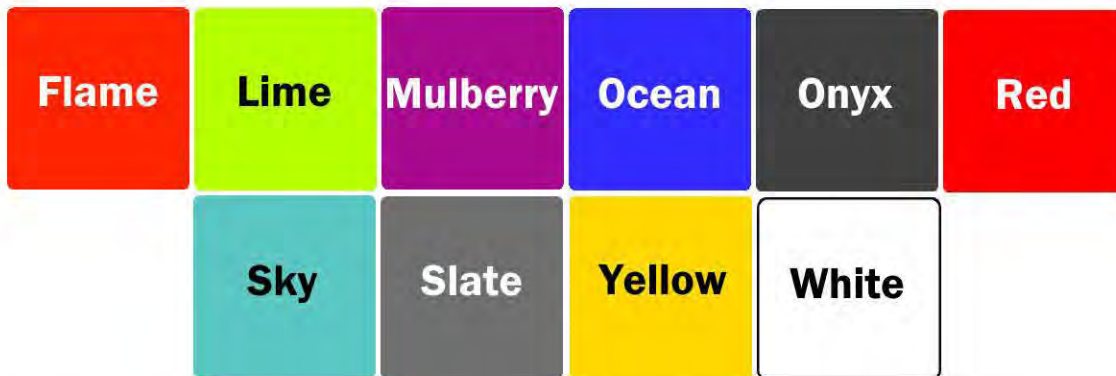

Order Code	Description	Price
SRS-2018	350mm 4 Leg	£25.50
SRS-2019	380mm 4 Leg	£26.00
SRS-2020	430mm 4 Leg	£26.50
SRS-2021	460mm 4 Leg	£27.00
SRS-2022	350mm Skidbase	£35.00
SRS-2023	380mm Skidbase	£35.50
SRS-2024	430mm Skidbase	£35.75
SRS-2025	460mm Skidbase	£36.00



0845 6033 606



sales@schoolsrus.co.uk

11

Advanced Classroom Chairs

4 Leg and Skidbase versions available

Advanced Poly Chairs

These popular poly chairs offer fantastic value for money.

EN1729 Part 2 tested for strength and stability.

Stacks 10 high when not in use

Skidbase version only available in sizes 430mm and 460mm.



* 430mm and 460mm ONLY

Choose from either Black or Light Grey frames.

Order Code	Description	Price
SRS-2153	310mm 4 Leg	£18.40
SRS-2154	350mm 4 Leg	£18.95
SRS-2155	380mm 4 Leg	£19.45
SRS-2156	430mm 4 Leg	£20.15
SRS-2157	460mm 4 Leg	£20.50
SRS-2158	430mm Skidbase	£22.80
SRS-2159	460mm Skidbase	£23.25



Not sure what size? Turn to page 2 for our size guide.

Advanced Bulk Purchase Poly

Amazing savings for your exam halls and classrooms



Special offer on Petrol Blue or Black Advanced Poly Chairs
Perfect for use in exam halls and classrooms

430mm or 460mm seat height only
Black or Petrol Blue shells only as pictured above
Black frames
Minimum order quantity of 50 applies

£18.95

Order Code: SRS-038

Not sure what size? Turn to page 2 for our size guide.



0845 6033 606



sales@schoolsrus.co.uk

13

Hille Series E Chairs

A popular classroom chair by Robin Day

5
YEARS
Guarantee

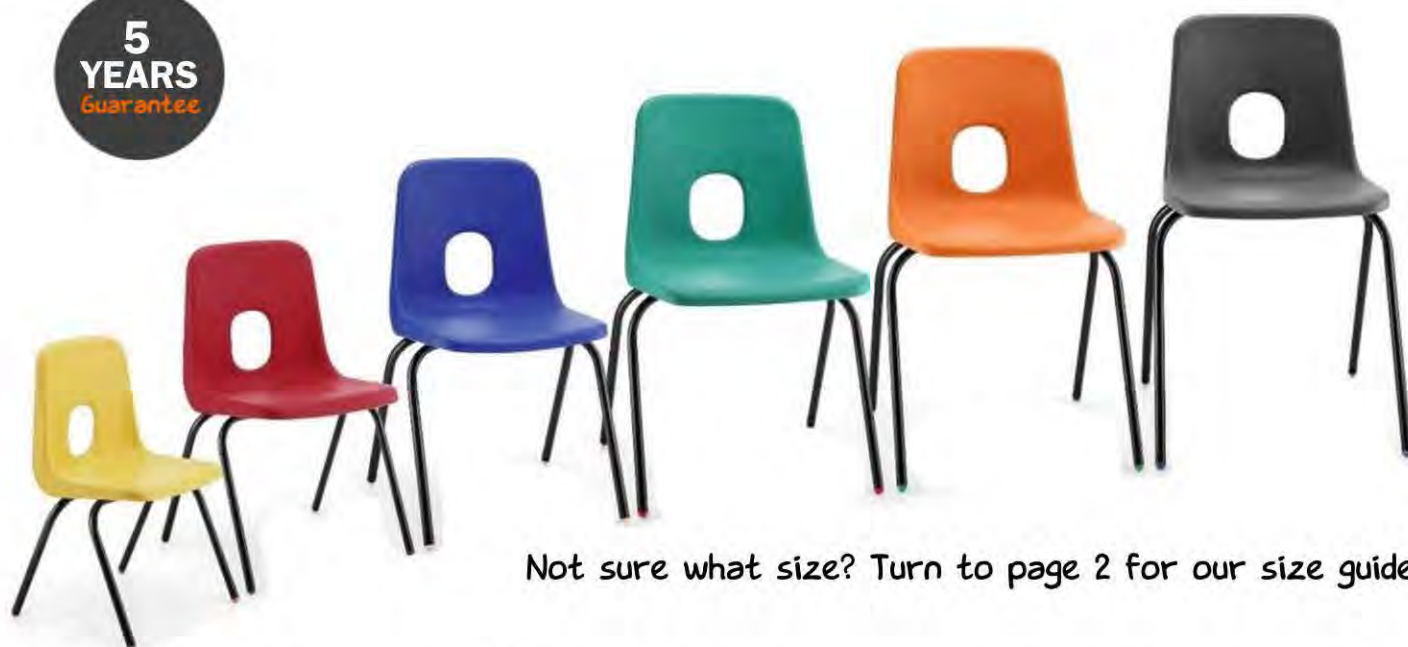

Not sure what size? Turn to page 2 for our size guide.

Available in 4 leg and skidbase versions, the Hille Series E range is durable and cost effective.

Frames constructed of high quality steel and painted with leatherite offering ultimate durability. Choose from Black or Light Grey frames.



Order Code	Description	Price
SRS-058	320mm 4 Leg Chair	£18.30
SRS-059	350mm 4 Leg Chair	£20.60
SRS-060	380mm 4 Leg Chair	£21.50
SRS-061	430mm 4 Leg Chair	£21.60
SRS-062	460mm 4 Leg Chair	£21.95
SRS-063	320mm Skidbase Chair	£21.45
SRS-064	350mm Skidbase Chair	£23.15
SRS-065	380mm Skidbase Chair	£25.15
SRS-066	430mm Skidbase Chair	£25.60
SRS-067	460mm Skidbase Chair	£25.95



Remploy GH20 Chairs

Available in a 4 leg or skidbase version

The GH20 range of chairs by Remploy offers fantastic value for money.

UK designed and manufactured using one piece polypropylene.

Stackable for easy storing.

Flint epoxy frame as standard.



Order Code	Description	Price
SRS-2006	310mm 4 Leg	£16.70
SRS-2007	350mm 4 Leg	£17.25
SRS-2008	380mm 4 Leg	£17.95
SRS-2009	430mm 4 Leg	£19.65
SRS-2010	460mm 4 Leg	£19.75
SRS-2011	430mm Skidbase	£31.20
SRS-2012	460mm Skidbase	£31.20

**Silver frames are available at a surcharge.
Please add £1.25 per chair if required.**

Not sure what size? Turn to page 2 for our size guide.



0845 6033 606



sales@schoolsrus.co.uk

15

Metalliform Classroom Chairs

Available in a range of vibrant colours

ST Chairs

Anti-tilt design.
Stackable up to 10 high.
Comfortable and supportive.
BSEN 1729 compliant.
Duraform speckled grey frames.

15
YEARS
Guarantee

Duraform Light
Speckled Grey
frames

Order Code	Seat Height	6-99	100+
SRS-1061	310mm	£22.35	£21.85
SRS-1062	350mm	£27.00	£26.50
SRS-1063	380mm	£27.65	£27.15
SRS-1064	430mm	£35.25	£34.75
SRS-1065	460mm	£35.75	£35.25



Chair 2000

Available with either 4 leg or skidbase frames (size 5 and 6 only).
Extremely strong and durable.
Stackable 7 high.

5
YEARS
Guarantee

Order Code	Description	6-99	100+
SRS-1066	310mm 4 Leg	£27.85	£27.35
SRS-1067	350mm 4 Leg	£28.35	£27.85
SRS-1068	380mm 4 Leg	£33.00	£32.50
SRS-1069	430mm 4 Leg	£34.00	£33.50
SRS-1070	460mm 4 Leg	£35.00	£34.50
SRS-1071	430mm Skidbase	£39.00	£38.50
SRS-1072	460mm Skidbase	£39.50	£39.00



Frame colours:



Metaliform Classroom Chairs

Available in a range of vibrant colours

BS Chairs

The BS Chairs boast an unbeatable and durable new design with excellent lumbar support. Stackable up to 5 high. BS EN1729 compliant.

Frame colours:



Order Code	Seat Height	6-99	100+
SRS-1051	310mm	£24.85	£24.35
SRS-1052	350mm	£28.00	£27.50
SRS-1053	380mm	£28.30	£27.80
SRS-1054	430mm	£33.70	£33.20
SRS-1055	460mm	£34.00	£33.50

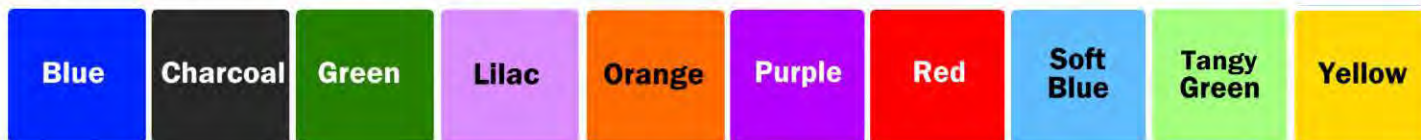

NP Chairs

The NP Chair is a classic classroom chair that is stackable up to 8 high for easy storage. Fully BS EN1729 compliant. Well defined lumbar support.

Frame colours:



Order Code	Seat Height	6-99	100+
SRS-1056	310mm	£18.90	£18.40
SRS-1057	350mm	£23.50	£23.00
SRS-1058	380mm	£24.00	£23.50
SRS-1059	430mm	£25.75	£25.25
SRS-1060	460mm	£26.85	£26.35

Not sure what size? Turn to page 2 for our size guide.

Remploy Classroom Chairs

Offering fantastic value for money

MX24 Chairs

Durable and attractive - this two piece chair boasts a heavy duty polypropylene seat and back along with a 22mm high tensile steel frame.

Order Code	Seat Height	Price
SRS-2026	310mm	£21.35
SRS-2027	350mm	£25.00
SRS-2028	380mm	£25.25
SRS-2029	430mm	£27.50
SRS-2030	460mm	£27.75

5
YEARS
Guarantee



For Silver frames - please add £1.25



5
YEARS
Guarantee

MX05 High Chairs

Perfect for use in science labs and art rooms.

Hardwearing feet to protect classroom and laboratory floors.

Strong and durable frame.

Order Code	Seat Height	Price
SRS-2031	560mm	£39.95
SRS-2032	610mm	£39.95
SRS-2033	660mm	£39.95

For Silver frames - please add £1.25



Hille Classroom Chairs

Amazing savings with the ECO Chair

Hille Eco Chairs - SPECIAL OFFER



Available in sizes 430mm and 460mm.

Recycled Black shells as standard.

The most cost effective solution for areas in schools where large volumes of seating are required.

Stacks for easy storing.

Order Code	Seat Height	1-49	50-99	100+
SRS-2039	430mm	£16.85	£15.80	£15.00
SRS-2060	460mm	£17.55	£16.50	£15.70

Hille Affinity Chairs

An incredibly popular choice of classroom chair offering exceptional value for money. Available in 4 colours as pictured below.

Black or Light Grey frames.



Order Code	Seat Height	Price
SRS-2034	310mm	£18.15
SRS-2035	350mm	£18.75
SRS-2036	380mm	£19.75
SRS-2037	430mm	£20.15
SRS-2038	460mm	£21.50

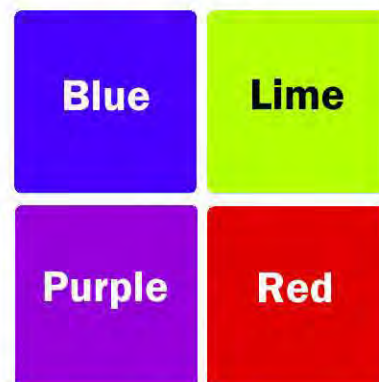

Hatton Chairs

Vibrant stacking chairs



5 YEARS
Guarantee

The Hatton Chair is a multi-purpose polypropylene chair suitable for canteens and classrooms.

Available in 8 colours.

Stacks 8 high freestanding or 16 high on its dolly.



* Please note, these colours are being discontinued.



Order Code	Description	Price
SRS-2161	Hatton Chair 455mm	£33.75
SRS-2162	Hatton Chair Dolly	£210.00



Titan and Postura ICT Chairs

The most popular swivel chairs for schools

Titan Swivel Chairs and Stools

Innovative and stylish.

Excellent user comfort for either students or teachers and can easily be adjusted to suit a user's weight.

Order Code	Description	Price
SRS-095	Junior Swivel Chair 365-435mm	£56.00
SRS-096	Senior Swivel Chair 435-525mm	£66.50
SRS-105	Junior Swivel Stool 405-475mm	£58.50
SRS-106	Senior Swivel Stool 465-555mm	£60.00

10 YEARS
Guarantee



Postura Plus Swivel Chairs and Stools

The Postura Plus range of ICT seating is renowned for its quality and vibrant colour selection. Easily adjustable to suit a user's weight.

Order Code	Description	Price
SRS-099	Postura Swivel Chair	£71.95
SRS-107	Postura Swivel Stool	£67.95

20 YEARS
Guarantee



Poly Swivel Chairs

Ergonomic and reliable



5 YEARS
Guarantee

Geo Poly Swivel Chairs

The GEO Poly Swivel Chair has been designed to give excellent ergonomic support to the user.

Available with Castors or Glides.

Order Code	Description	Price
SRS-097	GEO Swivel Chair	£75.95



Advanced Poly Chairs

The Advanced Chairs can be supplied as a no removable parts gas lift ICT chair.

Height adjustable from 460-600mm.

Available with Castors or Glides.

5 YEARS
Guarantee



Order Code	Description	Price
SRS-098	Advanced Swivel	£66.50



Postura and Titan Lab Stools

Ergonomically designed lab stools

Postura Plus Stools

Postura Plus Stools are a fantastic choice for schools. Manufactured to the highest UK quality. Bag hook underneath the seat. New seat colours for 2024. Available with Black or Silver Grey frames.



5 YEARS Guarantee

Order Code	Seat Height	1-199	200+
SRS-109	560mm	£51.50	£49.50
SRS-110	610mm	£52.00	£50.00
SRS-111	685mm	£52.50	£50.50



Titan Ultimate Lab Stools

This stool offers fantastic value for money and features an ergonomically designed seat with integral lumbar support. Stacks when not in use.

20 YEARS Guarantee

Order Code	Seat Height	Price
SRS-112	455mm	£32.50
SRS-113	560mm	£32.50
SRS-114	610mm	£32.95
SRS-115	685mm	£32.95



New slimmer frames for 2024.



0845 6033 606



sales@schoolsrus.co.uk

23

Poly Lab Stools

Please note these are non-returnable products

Advanced Poly Stools

Manufactured from 25mm steel tube with welded footrests.

Renowned for their strength.

Fantastic value for money.

Black or Light Grey frames.



Order Code	Seat Height	Price
SRS-116	445mm	£28.50
SRS-117	560mm	£28.75
SRS-118	610mm	£29.50
SRS-119	685mm	£30.00
SRS-120	755mm	£30.50



Hille Flat Top Stools

Choose from Black or Light Grey frames. 11 seat colour choices.

Fantastic value for money.

Order Code	Seat Height	Price
SRS-121	430mm	£26.50
SRS-122	525mm	£26.50
SRS-123	610mm	£26.50
SRS-124	685mm	£26.50



WSM Stools

Please note these are non-returnable products

WSM Stools

WSM Stools are an incredibly popular choice of science lab stool available in a 4 leg or skidbase version.

These stools are specified for major projects countrywide due to their unique seat shape with integral lumbar support.

Choice of 10 vibrant colours.

Please specify whether you require Black or Light Grey frames.



5
YEARS
Guarantee

Order Code	Description	Price
SRS-125	4 Leg Version - 445mm	£35.00
SRS-126	4 Leg Version - 560mm	£35.00
SRS-127	4 Leg Version - 610mm	£35.00
SRS-128	4 Leg Version - 685mm	£35.00
SRS-129	4 Leg Version - 755mm	£35.00
SRS-130	Skidbase Version - 445mm	£39.75
SRS-131	Skidbase Version - 560mm	£39.75
SRS-132	Skidbase Version - 610mm	£39.75
SRS-133	Skidbase Version - 685mm	£39.75
SRS-134	Skidbase Version - 755mm	£39.75



0845 6033 606



sales@schoolsrus.co.uk

25

Wooden Lab Stools

Please note these are non-returnable products



Heavy Duty Wooden Lab Stools

22mm diameter four-legged steel frame coated in an Epoxy powder coated finish for maximum life.

Easily lifted using the hand hole.

19mm diameter bracing bar to give extra strength to the frame.

Choose from Black or Light Grey frames.

Order Code	Seat Height	Price
SRS-140	445mm	£31.95
SRS-141	560mm	£31.95
SRS-142	610mm	£31.95
SRS-143	685mm	£31.95



Solid Beech Stools

Lift with ease via the useful hand hole on the seat.

Manufactured in the UK to the highest standards.

Sturdy yet comfortable.

610mm seat height as standard.



£59.00

Order Code: SRS-144



EN One High Chairs and Stools

Exciting new products for 2024

Introducing EN One High Chairs and Stools - brand new, all-polypropylene products to consider for your science labs.

This innovative design boasts unparalleled stackability, setting it apart from any other high chair or lab stool on the market.

Its seamless construction makes it an ideal fit for lab settings, as it effortlessly withstands spills and is remarkably easy to clean.



Available in all EN One colours

Banana Yellow

Black

Bottle Green

Cherry Red

Lime Green

Mandarin Orange

Night Grey

Sky Blue

Royal Blue

Velvet Purple

White



Try before you buy. Get in touch for a sample

Order Code	Description	Price
SRS-2415	Lab Stool 610mm	£46.00
SRS-2416	Lab Stool 685mm	£47.00
SRS-2417	High Chair 610mm	£51.50
SRS-2418	High Chair 685mm	£52.50
SRS-2419	Optional Bag Hook	£3.00



0845 6033 606



sales@schoolsrus.co.uk

27

High Chairs

Please note: these are non-returnable products

NP High Chairs

NP High Chairs are comfortable, practical and durable making them a fantastic choice for school science labs and art rooms.

Well defined lumbar support.

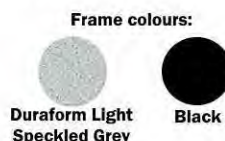

Order Code	Seat Height	Price
SRS-2167	610mm	£33.50
SRS-2168	685mm	£34.00



Hille Series E High Chair

Durable yet comfortable.

Choose from a Black or Light Grey frame.

Available in a range of colours.



Order Code	Seat Height	Price
SRS-2169	575mm	£34.00
SRS-2170	610mm	£34.00
SRS-2171	685mm	£34.00



High Chairs

Please note: these are non-returnable products



20 YEARS
Guarantee

New Slimmer
Frame for 2024

Titan High Chairs

Unique frame style protects all lab flooring and matting. Features full Titan ergonomic shell with full back support. Does not stack.

Order Code	Seat Height	Price
SRS-150	455mm	£41.00
SRS-151	560mm	£41.00
SRS-152	610mm	£43.50
SRS-153	685mm	£43.50



Postura High Chairs

Ergonomic and stylish, moulded from high impact resistant polypropylene. Anti-static and stain resistant. Stacks up to 5 high when not in use. Black or Silver Grey frame.

5 YEARS
Guarantee



Order Code	Seat Height	1-199	200+
SRS-154	560mm	£56.00	£54.00
SRS-155	610mm	£57.00	£55.00
SRS-156	685mm	£60.00	£58.00



0845 6033 606



sales@schoolsrus.co.uk

29

High Chairs

Please note: these are non-returnable products

GEO High Chairs

Choose from either a Black or Light Grey frame.
UK manufactured.

Order Code	Seat Height	Price
SRS-2303	610mm	£61.95
SRS-2304	685mm	£61.95
SRS-145	735mm	£61.95
SRS-146	795mm	£61.95



Advanced High Chairs

Round steel tube frame with welded footrests.

Black or Light Grey frames.

Order Code	Seat Height	Price
SRS-147	610mm	£35.75
SRS-148	660mm	£35.75
SRS-149	735mm	£35.75



High Chairs

Please note: these are non-returnable products



Harmony High Chairs

Solid one piece tamperproof seat and back for comfort and lumbar support. Choice of Black or Light Grey frame. Stacks up to 5 high when not in use. Non-scratch replaceable nylon feet.

Order Code	Seat Height	Price
SRS-157	610mm	£48.00
SRS-2041	685mm	£48.00
SRS-2042	735mm	£48.00
SRS-2301	795mm	£48.00



Masterstack High Chairs

Skid base high chair with tamperproof fixings and non-scratch replaceable nylon feet. Choice of Black or Light Grey frame. UK manufactured.



Order Code	Seat Height	Price
SRS-158	610mm	£48.00
SRS-2043	685mm	£48.00
SRS-2044	735mm	£48.00
SRS-2302	795mm	£48.00



Folding Chairs

Durable, practical and cost effective

These tough, lightweight and ultra-practical chairs are perfect for use in areas within schools that require large volumes of seating.

Choose from either Flat Back or Fan Back folding chairs.



Flat Back Folding Chairs

W450 x D498 x SH445mm

£14.95

Order Code: SRS-167



Fan Back Folding Chairs

W445 x D550 x SH445mm

£15.50

Order Code: SRS-168

Please note Flat Back Folding Chairs do not link.
Fan Back Folding Chairs feature integral linking devices.

Blue

Burgundy

Charcoal



Folding Chair Bundle Deals

A cost effective solution for school halls

Save further with a bundle deal.

All bundle deals include chairs, storage trolley and storage strap.

- 40 Flat Back Bundle**
£635.00 SRS-2431
- 60 Flat Back Bundle**
£1125.00 SRS-2432
- 40 Fan Back Bundle**
£660.00 SRS-2433
- 60 Fan Back Bundle**
£1150.00 SRS-2434



Offering the best value for money

Folding Chair Trolleys

Store and transport your folding chairs

Easy to manoeuvre and assemble. Heavy duty locking castors.

40 Chair, 70 Chair and 140 Chair trolley available.

Comfort / Comfort Plus store at half capacity (e.g 20 chairs on 40 trolley)

140 Trolley requires a 2.25m door clearance.



140 Chair Trolley

Storage Straps available providing safe and secure storage of the chairs.



70 Chair Trolley

Order Code	Description	Price
SRS-171	40 Trolley L1029xW470xH1500mm	£145.00
SRS-172	70 Trolley L1750xW790xH1100mm	£230.00
SRS-173	140 Trolley L1750xW790xH2250mm	£379.00
SRS-174	Storage straps for trolleys	£20.00



0845 6033 606



sales@schoolsrus.co.uk

33

Tilt Top Tables

Perfect for school classrooms and canteens



Octagonal Tilt Top Folding Tables With ST Chairs

Table Height Options

Table Height	Chair Height / Age
590mm	350mm / 5-7 Years
640mm	380mm / 7-9 Years
710mm	430mm / 9-13 Years
760mm	460mm / 13+ Years



Oval



Rectangular



Circular

Perfect for classrooms and canteens. Easy to open and close, then wheel away and store. Supplied with 4 locking castors. Available in 4 shapes: Circular, Octagonal, Oval and Rectangular.

Order Code	Description	2-29	30+
SRS-1077	Circular - 1200mm Diameter	£245.00	£240.00
SRS-1078	Oval - L1610 x W900mm	£329.00	£324.00
SRS-1079	Octagonal - L1200 x W1200mm	£260.00	£255.00
SRS-1080	Octagonal - L1380 x W1000mm	£260.00	£255.00
SRS-1081	Rectangular - L1200 x W900mm	£229.00	£224.00
SRS-2330	Rectangular - L1500 x W900mm	£272.00	£267.00



Exam Desks

Be prepared for exam season with our low cost desks

Economy and Premium Exam Desks

Our Economy Desks feature 15mm tops and 18mm frames. Premium Desks feature 19mm tops, 22mm frames and the addition of a safety bar to keep the desk open.

Supplied with pen groove, steel support clips and a large 600x600mm workspace.

Order Code	Description	1-100	101-199	200+
SRS-290	Economy	£24.00	£23.50	£23.00
SRS-291	Premium	£26.50	£26.00	£25.50



20/25 Capacity Trolley



Order Code: SRS-1035
£175.00

Titan 40 Exam Desk Trolley



Order Code: SRS-289
£215.00

Titan Exam Desks

Large 600x600mm workspace.
One piece polypropylene tops.
Graffiti proof with easy wipe clean tops.
'Snapping' lock mechanism ensures the exam desks will never collapse.
Extra strong over steel frames.
Pen groove. Folds away when not in use.
Up to 50% lighter than traditional wooden desks.



1-100	101-199	200+
£32.00	£31.50	£31.00
Order Code: SRS-292		

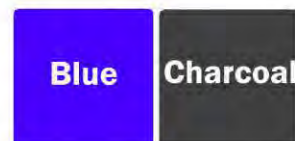

MDF Edge Crush Bent Tables

Affordable stacking tables



Table Height Options	
Table Height	Chair Height / Age
530mm	310mm / 3-5 Years
590mm	350mm / 5-7 Years
640mm	380mm / 7-9 Years
710mm	430mm / 9-13 Years
760mm	460mm / 13+ Years

These cost effective tables are a popular choice for schools. Where you require flexibility to regularly move tables or store them away, these are the best option. The legs on the tables are slightly wider than the top to enable them to be stacked one on top of the other, as pictured.

Order Code	Description	1-29	30+
SRS-1012	Square L600 x W600mm	£52.00	£51.50
SRS-1013	Rectangular L1100 x W550mm	£65.00	£64.50
SRS-1014	Rectangular L1200 x W600mm	£65.00	£64.50
SRS-1015	Trapezoidal L1100 x W550mm	£65.00	£64.50
SRS-1016	Trapezoidal L1200 x W600mm	£65.00	£64.50

Top Colours

Frame Colours



MDF Edge Fully Welded Tables

Cost Effective and Reliable



Cost-effective and durable tables with strong, fully welded non-stacking frames and solid wooden tops with MDF edging.



Optional Trays and Runners

1100x550mm (2 Trays & Runners)

£26.95

1200x600mm (2 Trays & Runners)

£26.95

Table Height Options

Table Height	Chair Height / Age
530mm	310mm / 3-5 Years
590mm	350mm / 5-7 Years
640mm	380mm / 7-9 Years
710mm	430mm / 9-13 Years
760mm	460mm / 13+ Years

Order Code	Description	1-29	30+
SRS-1017	Square L600 x W600mm	£52.00	£51.50
SRS-1018	Rectangular L1100 x W550mm	£65.00	£64.50
SRS-1019	Rectangular L1200 x W600mm	£65.00	£64.50
SRS-1020	Trapezoidal L1100 x W550mm	£65.00	£64.50
SRS-1021	Trapezoidal L1200 x W600mm	£65.00	£64.50
SRS-1022	Round - 1000mm Diameter	£105.00	£103.00

Top Colours

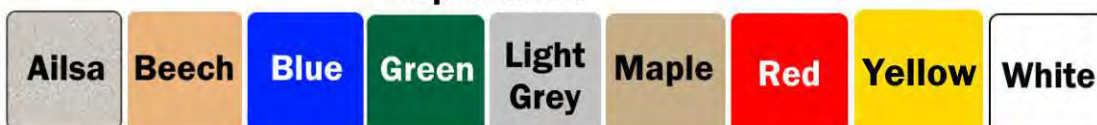

Frame Colours

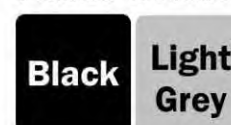

0845 6033 606



sales@schoolsrus.co.uk

37

PVC Edge Crush Bent Tables

Brighten up the classroom



Table Height Options	
Table Height	Chair Height / Age
530mm	310mm / 3-5 Years
590mm	350mm / 5-7 Years
640mm	380mm / 7-9 Years
710mm	430mm / 9-13 Years
760mm	460mm / 13+ Years

PVC Edge Crush Bent Tables are perfect for use in classrooms where tables need to be moved and stacked away.

Order Code	Description	1-29	30+
SRS-1023	Square - L600 x W600mm	£56.50	£56.00
SRS-1024	Rectangular - L1100 x W550mm	£69.00	£68.50
SRS-1025	Rectangular - L1200 x W600mm	£69.00	£68.50
SRS-1026	Trapezoidal - L1100 x W550mm	£69.00	£68.50
SRS-1027	Trapezoidal - L1200 x W600mm	£69.00	£68.50

Top Colours



Frame Colours

PVC Edge Colours



Fully Welded PVC Edge Tables

Brighten up the classroom



Optional Trays and Runners

1100x550mm (2 Trays & Runners)

£26.95

1200x600mm (2 Trays & Runners)

£26.95

Table Height Options

Table Height	Chair Height / Age
530mm	310mm / 3-5 Years
590mm	350mm / 5-7 Years
640mm	380mm / 7-9 Years
710mm	430mm / 9-13 Years
760mm	460mm / 13+ Years

Order Code	Description	1-29	30+
SRS-1028	Square L600 x W600mm	£56.50	£56.00
SRS-1029	Rectangular L1100 x W550mm	£69.00	£68.50
SRS-1030	Rectangular L1200 x W600mm	£69.00	£68.50
SRS-1031	Trapezoidal L1100 x W550mm	£69.00	£68.50
SRS-1032	Trapezoidal L1200 x W600mm	£69.00	£68.50
SRS-1033	Round - 1000mm Diameter	£110.00	£108.00

Top Colours



Frame Colours

PVC Edge Colours



0845 6033 606



sales@schoolsrus.co.uk

39

Spray PU Crush Bent Tables

Brighten up the classroom

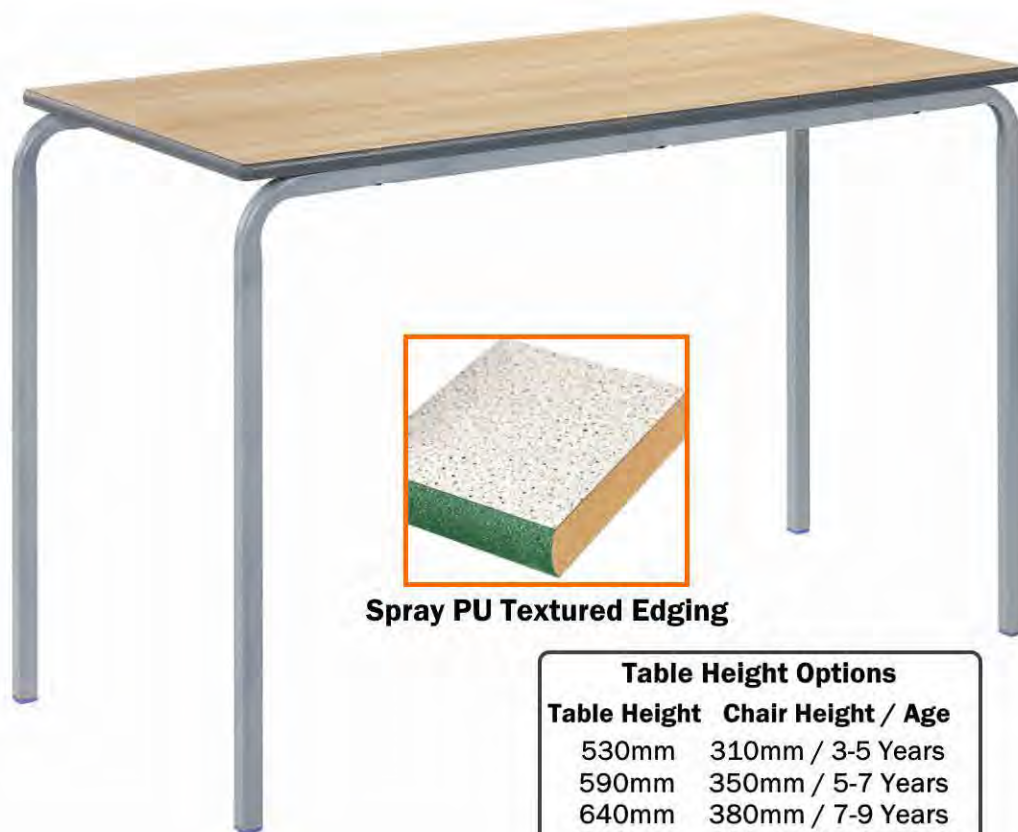

Spray PU Textured Edging

Table Height Options	
Table Height	Chair Height / Age
530mm	310mm / 3-5 Years
590mm	350mm / 5-7 Years
640mm	380mm / 7-9 Years
710mm	430mm / 9-13 Years
760mm	460mm / 13+ Years

Add a splash of colour into the classroom with Spray PU Edging. Crush Bent tables are perfect for classrooms requiring tables to be regularly moved and stored away.

Order Code	Description	1-29	30+
SRS-1001	Square L600 x W600mm	£61.00	£60.50
SRS-1002	Rectangular L1100 x W550mm	£74.00	£73.50
SRS-1003	Rectangular L1200 x W600mm	£74.00	£73.50
SRS-1004	Trapezoidal L1100 x W550mm	£74.00	£73.50
SRS-1005	Trapezoidal L1200 x W600mm	£74.00	£73.50

Top Colours



Frame Colours

Spray PU Finishes



Fully Welded Spray PU Tables

Brighten up the classroom

In most classrooms, tables are rarely moved. If this is the case for your classroom, we would recommend opting for Fully Welded Tables, offering full strength.



Brighten up the classroom with a Spray PU Edging available in a choice of colours.

Fully Welded Tables fit snugly against each other and 3 or 4 tables can be stacked spirally if necessary.



Optional Trays and Runners
 1100x550mm (2 Trays & Runners) **£26.95**
 1200x600mm (2 Trays & Runners) **£26.95**

Table Height Options	
Table Height	Chair Height / Age
530mm	310mm / 3-5 Years
590mm	350mm / 5-7 Years
640mm	380mm / 7-9 Years
710mm	430mm / 9-13 Years
760mm	460mm / 13+ Years

Order Code	Description	1-29	30+
SRS-1006	Square L600 x W600mm	£61.00	£60.50
SRS-1007	Rectangular L1100 x W550mm	£74.00	£73.50
SRS-1008	Trapezoidal L1100 x W550mm	£74.00	£73.50
SRS-1009	Rectangular L1200 x W600mm	£74.00	£73.50
SRS-1010	Trapezoidal L1200 x W600mm	£74.00	£73.50
SRS-1036	Rectangular L1200 x W750mm	£88.50	£88.00
SRS-1037	Rectangular L1500 x W750mm	£149.00	£148.00
SRS-1039	Rectangular L1800 x W750mm	£195.00	£193.00
SRS-1040	Round - 1000mm Diameter	£105.00	£103.00
SRS-1041	Square L750 x W750mm	£78.00	£77.00

Top Colours

Ailsa Beech Blue Green Light Grey Maple Red Yellow White Black Light Grey

Spray PU Edge Colours

Charcoal Blue Light Grey Green Red

Enviro Early Years Tables

Perfect for early years classrooms



Bean



Keyhole



Round



Daisy

Table Height Options	
Table Height	Chair Height / Age
530mm	310mm / 3-5 Years
590mm	350mm / 5-7 Years
640mm	380mm / 7-9 Years
710mm	430mm / 9-13 Years

Gopak Enviro Early Years Tables are a huge hit with pre-schools and primary schools. Wipe clean tops. Aluminium frames. Lightweight without compromising quality. Delivered flat packed for easy self assembly. Allen key supplied to permanently secure the legs.

Order Code	Description	1-4 Tables	5+ Tables
SRS-271	Keyhole Table - 1500mm Diameter	£262.00	£252.00
SRS-272	Bean Table L1400 x W750mm	£145.00	£135.00
SRS-273	Daisy Table L1200 x W1200mm	£198.00	£188.00
SRS-274	Trapezoidal Table L1400 x W560mm	£145.00	£135.00
SRS-275	Rectangular Table L1200 x W600mm	£136.00	£126.00
SRS-276	Round Table - 1200mm Diameter	£190.00	£180.00

Available in a range of vibrant Top Colours:



Edge Colours:



Segga Tables

Perfect for classrooms, libraries and ICT suites



Create unique shape combinations in the library or classroom using these stylish modular tables featuring 32mm fully welded frames with 18mm laminate tops.

Ultimate flexibility for any classroom or project. Perfect for creating ICT hot desks.

Frame Colours



Order Code	Description	1-29	30+
SRS-1082	Segga Table L750 x W660mm	£105.00	£102.00
SRS-1083	Segga Table With Non-Locking Castors - L750 x W660mm	£140.00	£137.00

Top Colours

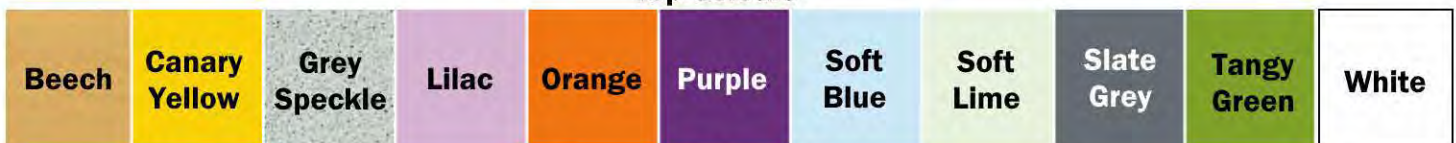

Spray PU Edge Options



0845 6033 606



sales@schoolsrus.co.uk

43

Equation Tables

Modular tables to modernise the classroom



Circular Equation Table
Paired With ST Chairs

An exciting range of modular tables with 32mm round frames and tamperproof fixings. 25mm premium tops and height adjustable feet.

Table Height Options

Table Height	Chair Height / Age
530mm	310mm / 3-5 Years
590mm	350mm / 5-7 Years
640mm	380mm / 7-9 Years
710mm	430mm / 9-13 Years
760mm	460mm / 13+ Years



Order Code	Description	1-29	30+
SRS-1084	Rectangular L1100 x W550mm	£130.00	£128.00
SRS-1085	Rectangular L1200 x W600mm	£134.00	£132.00
SRS-1086	Square L600 x W600mm	£90.00	£88.00
SRS-1087	Trapezoidal L1100 x W550mm	£135.00	£133.00
SRS-1088	Trapezoidal L1200 x W600mm	£135.00	£133.00
SRS-1089	Circular - 1100mm Diameter	£239.00	£237.00
SRS-1090	Circular - 1200mm Diameter	£250.00	£248.00
SRS-1091	Semi-Circular - 1200mm Diameter	£140.00	£138.00

Top Colours for all Equation Tables (page 44 and 45)



Spray PU Edge Colours for all Equation Tables (page 44 and 45)



Equation Tables

Modular tables to modernise the classroom



Jewel Leaf

Create funky classroom configurations

An exciting range of modular tables designed to modernise the classroom. Features 32mm round frames, 25mm tops with premium finishes, Duraform edging, tamperproof fixings and height adjustable feet.

Order Code	Description	1-29	30+
SRS-1092	Arc Tables - L1490 x W600mm	£305.00	£300.00
SRS-1093	Leaf Tables - L1220 x W870mm	£145.00	£140.00
SRS-1094	Jewel Tables - L1440 x W840mm	£210.00	£205.00



Arc



Leaf

Frame Colours for all Equation Tables (page 44 and 45)



0845 6033 606



sales@schoolsrus.co.uk

45

RT32 Tables

High quality classroom tables



High quality classroom tables with solid 18mm MDF tops, MDF bullnose edge and 32mm round tubular frames.
Choice of 10 high pressure laminates finishes.

Order Code	Description	1-29	30+
SRS-2045	Square L600 x W600mm	£63.00	£62.00
SRS-2046	Rectangular L1100 x W550mm	£79.00	£78.00
SRS-2047	Trapezoidal L1100 x W550mm	£79.00	£78.00
SRS-2048	Rectangular L1200 x W600mm	£79.00	£78.00
SRS-2049	Trapezoidal L1200 x W600mm	£79.00	£78.00
SRS-2050	Rectangular L1500 x W750mm	£155.00	£154.00
SRS-2051	Round - 1100mm Diameter	£139.00	£138.00
SRS-2052	Round - 1200mm Diameter	£155.00	£154.00
SRS-2053	Semi Circular L1100 x W550mm	£79.00	£78.00
SRS-2054	Semi Circular L1200 x W600mm	£79.00	£78.00
SRS-2055	Square L750 x W750mm	£87.00	£86.00

Frame Options

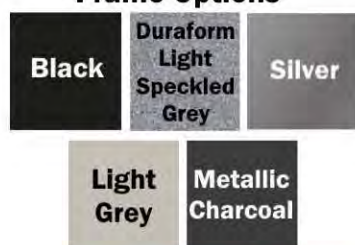

Upgrade to a Spray PU Edge for an additional £10.00 per table:



Top Colours



Self Assembly Classroom Tables

Delivered quickly from stock



From box to classroom in 5 minutes

Self Assembly Cast PU Edge Tables

If you have been let down by another supplier, or require a spare set of classroom tables, these tables are stocked, easy to build and can be assembled within 5 minutes per table.

Beech or Grey tops with a permanent Grey Cast PU Edge and Black strong frames.

Order Code	Description	5+ Price
SRS-2056	Square 600x600mm	£53.00
SRS-2057	Rectangular 1200x600mm	£71.00

Minimum order of 5 units applies.

Table Height Options	
Table Height	Chair Height / Age
590mm	350mm / 5-7 Years
640mm	380mm / 7-9 Years
710mm	430mm / 9-13 Years
760mm	460mm / 13+ Years



0845 6033 606



sales@schoolsrus.co.uk

47

Height Adjustable Tables

High quality tables with crank handle height adjustment

Top Colours



Upgrade to a Sprayed PU Edge - add £10.00 per table.



These tables can be supplied with castors for mobility at a cost of £25.00 per table.

Our Height Adjustable Tables have been developed to give you opportunity to have a table that can be adjusted to a number of heights, making them appropriate for wheelchair users.

Adjustable using the crank handle from 550mm to 820mm high.

Order Code	Description	Price
SRS-2058	Square W800 x D600mm	£310.00
SRS-2059	Rectangular W1000 x D600mm	£330.00
SRS-2060	Rectangular W1200 x D600mm	£355.00
SRS-2061	Rectangular W1400 x D600mm	£375.00
SRS-2062	Rectangular W1600 x D600mm	£400.00
SRS-2063	Square W800 x D800mm	£345.00
SRS-2064	Rectangular W1000 x D800mm	£365.00
SRS-2065	Rectangular W1200 x D800mm	£385.00
SRS-2066	Rectangular W1400 x D800mm	£405.00
SRS-2067	Rectangular W1600 x D800mm	£425.00



Whiteboard Top Tables

Paperless, wipe clean learning



Frame Colours

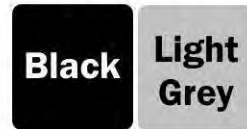

Table Height Options

Table Height	Chair Height / Age
530mm	310mm / 3-5 Years
590mm	350mm / 5-7 Years
640mm	380mm / 7-9 Years
710mm	430mm / 9-13 Years
760mm	460mm / 13+ Years

Whiteboard Top Tables are an innovative new product introducing a new paperless way of teaching in the classroom.

Wipe clean, scratch resistant surfaces made from hardwearing 18mm high gloss. Choice of frame and edge colours.

Order Code	Description	Price
SRS-2068	Rectangular L1100 x W550mm	£84.00
SRS-2069	Rectangular L1200 x W600mm	£84.00
SRS-2070	Square L600 x W600mm	£71.00
SRS-2071	Circular - 1000mm Diameter	£115.00
SRS-2072	Circular - 1100mm Diameter	£142.00
SRS-2073	Circular - 1200mm Diameter	£163.00

Spray PU Edge Colours



0845 6033 606



sales@schoolsrus.co.uk

49

Activity Tables

Perfect for group learning

Our Height Adjustable Theme Tables encourage group learning in the classroom, allowing teachers to interact with 5 students.



Arc



Clover



Flower



Horseshoe



Teacher's Flower



Activity Tables

Perfect for group learning



Rectangular

These tables feature 50mm height adjustable legs and tough 25mm tops with PVC edging and rounded edges for safety.

Height adjustable from 430mm to 625mm high.

Order Code	Description	Price
SRS-2074	Teacher's Flower W1530 x D1250mm	£400.00
SRS-2075	Horseshoe W1520 x D1390mm	£375.00
SRS-2076	Flower W1530 x D1440mm	£375.00
SRS-2077	Arc W1540 x D750mm	£285.00
SRS-2078	Clover W1130 x D1130mm	£285.00
SRS-2079	Rectangular W1200 x D600mm	£245.00
SRS-2080	Rectangular W1100 x D550mm	£245.00

Top Colours



0845 6033 606



sales@schoolsrus.co.uk

51

Super Heavy Duty Tables

With optional pedestals to create Teacher's Desks

Super Heavy Duty Work Tables / Teachers Desks

A versatile range of super strong tables that can become Teachers Desks with the addition of pedestals.



Heavy Duty Tables from

£117.00

Fully Welded
30mm Frames

Shown with 2 drawer
pedestal unit (left hand)

Shown with 2 drawer filing
pedestal unit (right hand)

Delivered
Fully Assembled

7
YEARS
Guarantee

Height Adjustable
Feet

Order Code	Description	1-5	5+
SRS-313	Table W1200 x D600 x H725mm	£120.00	£117.00
SRS-314	Table W1200 x D750 x H725mm	£145.00	£142.00
SRS-315	Table W1500 x D600 x H725mm	£146.00	£143.00
SRS-316	Table W1500 x D750 x H725mm	£170.00	£167.00
SRS-317	Table W1800 x D600 x H725mm	£170.00	£167.00
SRS-318	Table W1800 x D750 x H725mm	£193.00	£190.00

Add on pedestals to create Teachers Desks

Order Code	Description	Price
SRS-319	2 Drawer Pedestal Unit	£82.00
SRS-320	2 Drawer Filing Pedestal Unit	£97.00

£30.00 delivery charge applies to any order below £345.00



Teachers Desks

These products can be mixed and matched for 3+ pricing

Single Pedestal Teacher's Desk

Durable 18mm MFC tops with 2mm edge banding.

62mm cable ports.

Metal to metal fixings.

725mm desk height.

18mm top thickness.

10mm adjustable feet.



Choose from 2 or 3 drawer fixed pedestal

5 YEARS Guarantee



Order Code	Description	1-2	3+
SRS-2082	W1200mm Desk	£168.00	£158.00

Double Pedestal Teachers Desks

Durable 18mm MFC tops with 2mm edge banding.

62mm cable ports.

Metal to metal fixings.

725mm desk height.

18mm top thickness.

10mm adjustable feet.



5 YEARS Guarantee



Order Code	Description	1-2	3+
SRS-2083	W1500mm Desk	£230.00	£220.00
SRS-2084	W1800mm Desk	£240.00	£230.00



0845 6033 606



sales@schoolsrus.co.uk

53

Budget Teachers Desks

Cost effective without compromising quality

Teacher's Desks with 18mm tops made from Grade E1 melamine faced high density particle board with a 1mm edging. Choose from a single pedestal with left or right hand positioning, or a double pedestal.

Single 3 Drawer Pedestal



Choose from
Light Oak with Brown Metal
or Beech with Brown Metal

Please specify
whether you
require 2 or 3
drawers

10
YEARS
Guarantee

Delivered
flat packed
for easy self
assembly

Double 2+3 Drawer Pedestal



Order Code	Description	Price
SRS-656	Single Pedestal L1200 x D745 x H720mm	£200.00
SRS-657	Single Pedestal L1500 x D745 x H720mm	£220.00
SRS-658	Single Pedestal L1800 x D745 x H720mm	£250.00
SRS-659	Double 2+3 Pedestal L1500 x D745 x H720mm	£285.00
SRS-660	Double 2+3 Pedestal L1800 x D745 x H720mm	£310.00



Locker Desks

A great alternative to standard classroom tables

Locker Desks are a great alternative to standard classroom tables.

Sturdy MFC construction with solid wood legs.

Durable lifting desk top.

Solid beech with a laminated MDF top.

Available as a single or double desk.

Delivered fully assembled
and ready to use



Order Code	Description	1-5	6+
SRS-2085	Single 600x400mm	£125.00	£120.00
SRS-2086	Double 1100x460mm	£190.00	£185.00

Please specify required height:
600mm, 650mm, 700mm or 750mm

Craft Tables

High quality tables for art and technology rooms



25mm Square Steel Tube
H-Frame

Available
700mm, 750mm,
800mm, 850mm
or 900mm high -
please specify
desired height
when placing
your order

Frame Colours



Top Colours

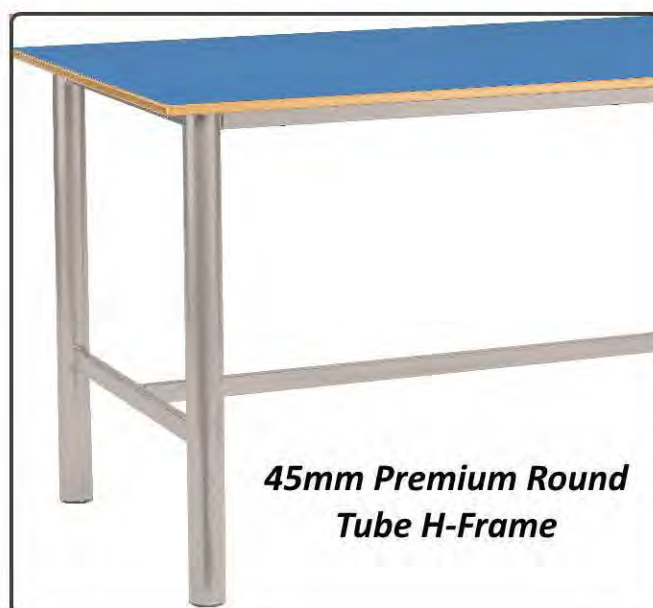

45mm Premium Round
Tube H-Frame

Order Code	Description	Price
SRS-2087	Square H-Frame L1200 x W600mm	£139.00
SRS-2088	Square H-Frame L1200 x W750mm	£154.00
SRS-2089	Square H-Frame L1500 x W750mm	£230.00
SRS-2090	Premium H-Frame L1200 x W600mm	£199.00
SRS-2091	Premium H-Frame L1200 x W750mm	£215.00
SRS-2092	Premium H-Frame L1500 x W750mm	£255.00



Science Tables

Designed to withstand the toughest of science labs

A comprehensive range of tables for science labs and tech rooms.

Trespa - solid laminate surface combining chemical resistance with a range of decorative finishes. Please visit www.trespa.com for a full list of colours, otherwise speckled grey will be supplied as standard.

Solid Iroko - 30mm finished in a durable clear water - borne lacquer finish.



Solid Iroko 30mm top with solid beech frame



Trespa top with solid beech frame

Order Code	Description	Price
SRS-303	Iroko Top, Beech Frame 1200x600mm	£470.00
SRS-304	Trespa Top, Beech Frame 1200x600mm	£415.00

Laboratory tables from

£235.00



Acid resistant 16mm solid trespa top

25 YEARS
Guarantee



Solid Iroko 30mm top

Order Code	Description	Iroko	Trespa
SRS-305	L1000 x W600mm	£300.00	£235.00
SRS-306	L1000 x W750mm	£350.00	£260.00
SRS-307	L1200 x W600mm	£340.00	£250.00
SRS-308	L1200 x W750mm	£410.00	£300.00
SRS-309	L1500 x W600mm	£430.00	£310.00
SRS-310	L1500 x W750mm	£475.00	£350.00
SRS-311	L1800 x W600mm	£485.00	£345.00
SRS-312	L1800 x W750mm	£550.00	£400.00

Table Height Options
700mm, 750mm, 800mm, 850mm or 900mm - please specify when ordering.



0845 6033 606



sales@schoolsrus.co.uk

57

Spaceright Canteen Units

High quality canteen units with vibrant colour options

Stool Colours for Premier Units



Laminate Top Colours For All Units

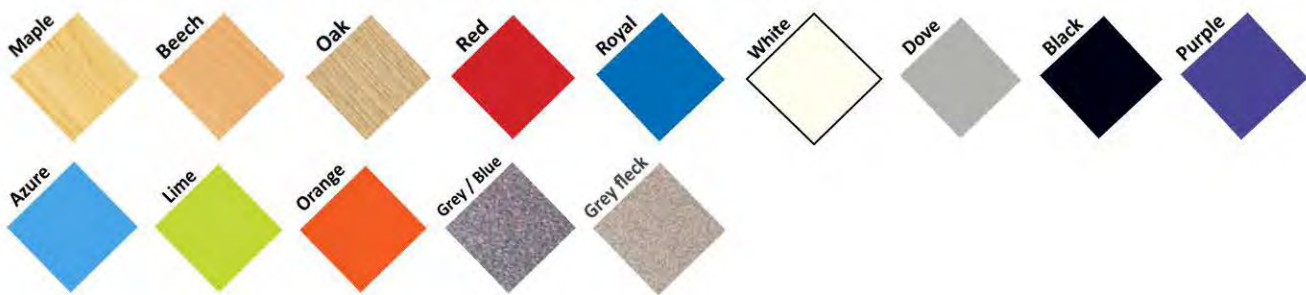

Premier Folding Seating Units



Our Spaceright Premier Folding Seating Units are round, octagonal or rectangular tables designed for school canteens.



Spaceright Canteen Units

High quality canteen units with vibrant colour options



Double braced legs for extra security.

Folds away easily and fits through a standard height doorway (1980mm) for storage and transportation.

Open position safety lock to keep the table open.

Easy-clean immediate lock for improved hygiene.

Choice of two sizes - Primary or Secondary.

Heavy duty locking castors.

FIRA certified.

16
YEARS
Guarantee

Order Code	Description (Number of Seats in Brackets)	Price
SRS-327	Rectangular (8) H685 x W1500 x L2380mm	£735.00
SRS-328	Rectangular (8) H735 x W1500 x L2380mm	£735.00
SRS-329	Rectangular (12) H685 x W1500 x L3080mm	£855.00
SRS-330	Rectangular (12) H735 x W1500 x L3080mm	£855.00
SRS-331	Rectangular (16) H650 x W1500 x L3280mm	£959.00
SRS-332	Round (8) H685mm x W2155mm	£865.00
SRS-333	Round (8) H735 x W2155mm	£865.00
SRS-334	Octagonal (8) H685 x W2155mm	£865.00
SRS-335	Octagonal (8) H735 x W2155mm	£865.00

Please specify size required. SRS-331 is for infants only. Colours on previous page.



0845 6033 606



sales@schoolsrus.co.uk

59

Spaceright Canteen Units

High quality canteen units with vibrant colour options

Laminate Top Colours For All Units

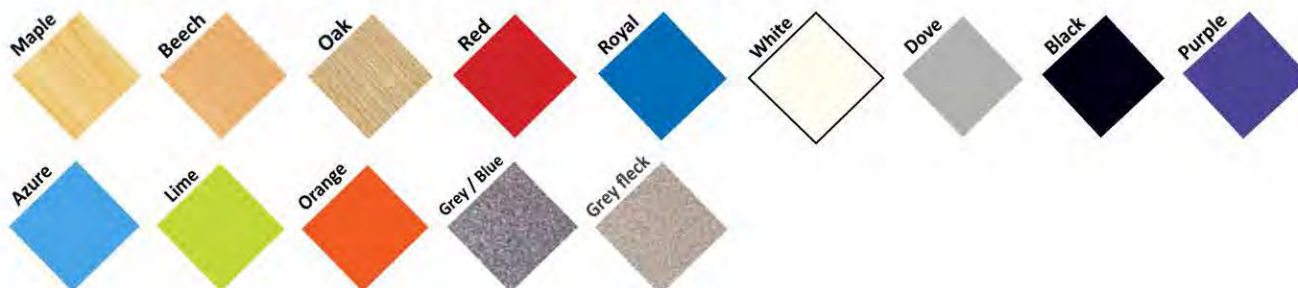

Premier Folding Table and Bench Units



16
YEARS
Guarantee

Mobile folding bench unit to seat 12-16 children. Laminated table top and bench with tough edging and MDF core. Water resistant and easy to clean. Open and closed position for safety locks. Heavy duty, lift off the floor castors. FIRA certified.

Order Code	Description	Price
SRS-342	L3080 x H685 x W1400mm	£815.00
SRS-343	L3080 x H735 x W1400mm	£815.00



Spaceright Canteen Units

High quality canteen units with vibrant colour options



Mobile Folding Bench Units

These units are completely versatile, offering 3 tables in 1.

They can convert into a classroom table and, by joining 2 together back to back, they can also create a cafeteria table.

Order Code	Description	Price
SRS-344	L2435 x H685 x W730mm	£569.95
SRS-345	L2435 x H735 x W730mm	£569.95

16
YEARS
Guarantee

Laminate Top Colours for All Units

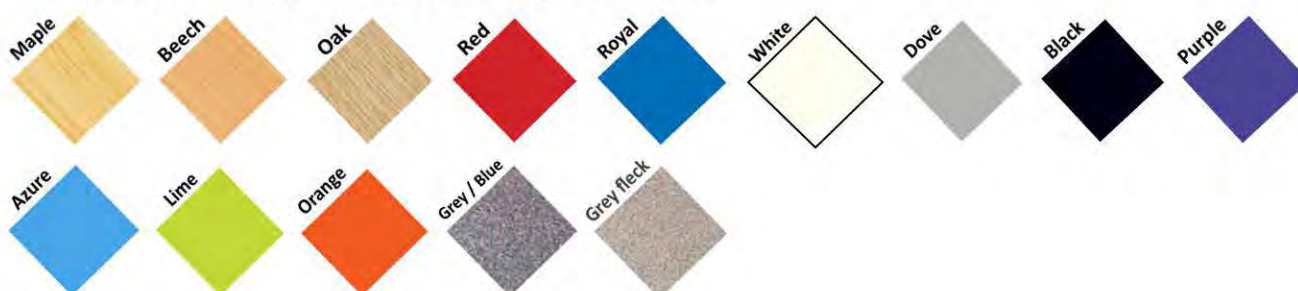

0845 6033 606



sales@schoolsrus.co.uk

61

Spaceright Canteen Units

High quality canteen units with a choice of wood finishes

Primo Mobile Folding Canteen Units



W3080 x D1500 x H767mm



DIA2155mm x H767mm



Spaceright Canteen Units

High quality canteen units with a choice of wood finishes

Primo Mobile Folding Canteen Units are contemporary, high quality dining tables with a choice of Gloss or Oak effect tops, and Oak seats as standard.

Designed for use in secondary, higher and further education establishments.

50mm thick laminated table top and grey frame.

Fits through a standard height doorway (1980mm) for storage and transportation.

Open position safety lock, and easy-clean immediate lock for easy clean.



Full Seats



Seats



Stools

**16
YEARS
Guarantee**

Order Code	Description	Price
SRS-2175	Rectangular with Stools	£1235.00
SRS-2176	Rectangular with Seats	£1310.00
SRS-2177	Rectangular with Full Seats	£1570.00
SRS-2178	Round with Stools	£1325.00
SRS-2179	Round with Seats	£1422.50
SRS-2180	Round with Full Seats	£1665.00

Please see left hand page for product dimensions.



0845 6033 606



sales@schoolsrus.co.uk

63

Monarch Tray Storage

With a vibrant selection of tray colours

SRS-422



SRS-419



SRS-425

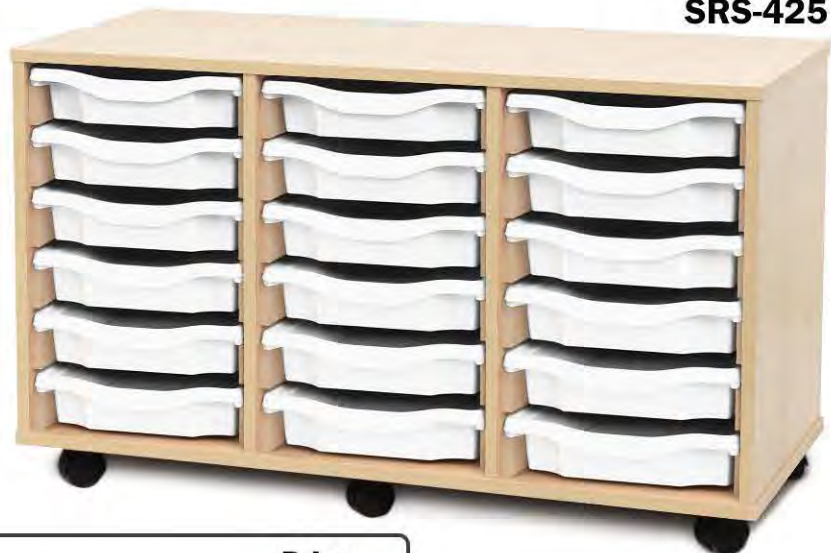

Beech or Maple carcass

Pictured tray colours:
Translucent, White, Yellow,
Lime, Cyan, Tangerine,
Pink and Purple

Single Column Tray Unit

Order Code	Description	Price
SRS-419	6 Tray Unit H617 x W360 x D453mm	£114.00
SRS-420	8 Tray Unit H789 x W360 x D453mm	£165.00



Double Column Tray Unit

Order Code	Description	Price
SRS-422	12 Tray Unit H617 x W700 x D453mm	£198.00
SRS-423	16 Tray Unit H789 x W700 x D453mm	£218.00

Triple Column Tray Unit

Order Code	Description	Price
SRS-425	18 Tray Unit H617 x W1030 x D453mm	£239.00
SRS-426	21 Tray Unit H703 x W1030 x D453mm	£249.00
SRS-427	24 Tray Unit H789 x W1030 x D453mm	£255.00
SRS-428	30 Tray Unit H961 x W1030 x D453mm	£334.00

Please see
next page
for tray
colours



Monarch Tray Storage

With a vibrant selection of tray colours



20 Tray
Pink Trays



24 Tray
Dark Grey Trays



28 Tray
Cyan, Pink, Tangerine + Yellow



32 Tray
Turquoise Trays

Delivered fully assembled. 18mm solid construction. Mobile or static.

Order Code	Description	Price
SRS-433	20 Tray Unit H531 x W1358 x D462mm	£269.00
SRS-434	24 Tray Unit H617 x W1358 x D462mm	£294.00
SRS-435	28 Tray Unit H703 x W1358 x D462mm	£321.00
SRS-436	32 Tray Unit H789 x W1358 x D462mm	£351.00
SRS-437	40 Tray Unit H961 x W1358 x D462mm	£419.00
SRS-438	48 Tray Unit H1133 x W1358 x D462mm	£484.00
SRS-439	64 Tray Unit H1477 x W1358 x D462mm	£599.00

Wood Finishes



Tray Colours



0845 6033 606



sales@schoolsrus.co.uk

65

Monarch Tray Storage

With a choice of coloured edging

Brighten up the classroom with this stunning range of Monarch classroom storage with coloured edging.



This range is available with Shallow or Jumbo trays.

Pair these units with our matching Bookcases + Cupboards



Enabling you to colour coordinate the classroom.



Monarch Tray Storage

With a choice of coloured edging

Wood Finishes



Edge Colour with Matching Trays



Coloured Edge Tray Storage Units - 4 Shallow Options and 2 Jumbo

Order Code	Description	Price
SRS-2380	6 Tray W360 x D453 x H617mm	£129.00
SRS-2381	12 Tray W700 x D453 x H617mm	£215.00
SRS-2382	18 Tray W1030 x D453 x H617mm	£245.00
SRS-2383	24 Tray W1030 x D453 x H789mm	£279.00
SRS-2384	8 Jumbo Tray W1358 x D453 x H739mm	£344.00
SRS-2385	12 Jumbo Tray W1358 x D453 x H1067mm	£381.00

Coloured Edge Bookcases

Order Code	Description	Price
SRS-2386	Bookcase 2 Shelves W900 x D320 x H750mm	£160.00
SRS-2387	Bookcase 3 Shelves W900 x D320 x H1250mm	£182.50
SRS-2388	Bookcase 5 Shelves W900 x D320 x H1800mm	£205.00

Coloured Edge Cupboards

Order Code	Description	Price
SRS-2389	Cupboards 2 Shelves W1030 x D477 x H768mm	£255.00
SRS-2390	Cupboards 3 Shelves W1030 x D477 x H1268mm	£325.00
SRS-2391	Cupboards 5 Shelves W1030 x D477 x H1818mm	£345.00



0845 6033 606



sales@schoolsrus.co.uk

67

Monarch Tray Storage

With a vibrant selection of tray colours



SRS-2814
Beech with Cyan trays



SRS-2182
Maple with Black trays



SRS-2187
Beech with Green, Blue,
Yellow and Red trays



SRS-2185
Maple with Metal Blue trays



SRS-2183
Beech with Tangerine trays



Monarch Tray Storage

With a vibrant selection of tray colours

Order Code	Description	Price
SRS-2181	12 Deep Tray Vertical W1030 x D453 x H835mm	£330.00
SRS-2182	12 Deep Tray Horizontal W1358 x D453 x H707mm	£330.00
SRS-2183	16 Deep Tray Unit W1358 x D453 x H835mm	£395.00
SRS-2184	18 Deep Tray Unit W1030 x D453 x H1210mm	£420.00
SRS-2185	6 Extra Deep Tray Unit W700 x D453 x H857mm	£210.00
SRS-2186	12 Extra Deep Tray Unit W1358 x D453 x H857mm	£365.00
SRS-2187	16 Extra Deep Tray Unit W1358 x D453 x H1115mm	£455.00



Heavy Duty Paper Storage Units

Designed to store away paper, cardboard and artwork.

Large storage units for A1 sheets of paper and are offered in six drawer or shelf options. Available mobile or static - please specify which you require when placing your order.

All drawer fronts are available in single or multicolour options.



Order Code	Description	Price
SRS-510	Heavy Duty Unit 4 Sliding Shelf H780 x W1015 x D780mm	£415.00
SRS-511	Heavy Duty Unit 4 Sliding Shelf and Doors H780 x W1015 x D780mm	£460.00
SRS-512	Heavy Duty 6 Drawer Beech or Maple H780 x W1015 x D780mm	£475.00

Monarch Tray Storage

With a vibrant selection of tray colours

Jumbo Tray Storage Units



Combination Tray Storage Units



Monarch Tray Storage

With a vibrant selection of tray colours

Order Code	Description	Price
SRS-2188	4 Jumbo Tray W700 x D453 x H739mm	£249.00
SRS-2189	6 Jumbo Tray Horizontal W1030 x D453 x H739mm	£354.00
SRS-2190	6 Jumbo Tray Vertical W700 x D453 x H1067mm	£274.00
SRS-2191	8 Jumbo Tray Unit W1358 x D453 x H739mm	£314.00
SRS-2192	9 Jumbo Tray Unit W1030 x D453 x H1067mm	£369.00
SRS-2193	12 Jumbo Tray Unit W1358 x D453 x H1067mm	£399.00
SRS-2194	24 Shallow / Deep Combo W1358 x D453 x H707mm	£335.00
SRS-2195	32 Shallow / Deep Combo W1358 x D453 x H835mm	£395.00
SRS-2196	36 Shallow / Deep Combo W1030 x D453 x H1210mm	£430.00

Wood Finishes



Tray Colours



0845 6033 606



sales@schoolsrus.co.uk

71

Monarch Bubblegum Storage

Available in a range of vibrant colours

SRS-2198



SRS-2201



Brighten up the classroom with these colourful storage units

SRS-2197



SRS-2199



Monarch Bubblegum Storage

Available in a range of vibrant colours



SRS-2202

Perfect for storing arts and crafts equipment

All Bubblegum Storage Units come with Maple finish as standard. Available with a choice of different trims and tray colours.

Order Code	Description	Price
SRS-2197	6 Shallow Tray W360 x D473 x H667mm	£152.50
SRS-2198	12 Shallow Tray W700 x D473 x H667mm	£225.00
SRS-2199	18 Shallow Tray W1030 x D473 x H667mm	£305.00
SRS-2200	24 Shallow Tray W1030 x D473 x H839mm	£380.00
SRS-2201	Bubblegum Lockers W1358 x D493 x H1067mm	£755.00
SRS-2202	Bubblegum Art Cupboard W1085 x D600 x H1503mm	£845.00
SRS-2203	Bubblegum Wardrobe W1085 x D600 x H1503mm	£940.00



SRS-2203

Trim and Tray Colours



Monarch Tray Storage

With a vibrant selection of tray colours



Wood Finishes

Beech Maple



All of our units are delivered fully assembled with trays

Optional doors available on all units

48 Tray Storage Unit only

£520.00



For Tray Colours, please refer to page 65

Order Code	Description	Price
SRS-443	48 Tray Unit H1468 x W1030 x D477mm	£520.00
SRS-444	48 Tray Unit + Doors H1468 x W1030 x D477mm	£590.00
SRS-445	60 Tray Unit H1810 x W1030 x D477mm	£560.00
SRS-446	60 Tray Unit + Doors H1830 x W1030 x D477mm	£650.00



Monarch Tray Storage

With a vibrant selection of tray colours

Wood Finishes

Beech

Maple



24 Tray Unit with Half Doors

£450.00

Order Code: SRS-440

24 Tray Unit with Full Doors

£520.00

Order Code: SRS-441



21 Tray Unit with 2 Shelves and Full Doors

£530.00

Order Code: SRS-442

Please see page 65 for Tray Colours



0845 6033 606



sales@schoolsrus.co.uk

75

Metal Tray Storage Units

Available with a choice of vibrant tray colours

16 Tray Unit only

£277.00

45 Trays



57 Trays



38 Trays



Fully welded frames available in Blue, Charcoal, Red or Grey.

Complete with trays and worktop.

16 Trays



24 Trays



For Tray Colours, please see page 65

Order Code	Description	Price
SRS-487	16 Tray H850 x W710 x D430mm	£277.00
SRS-488	24 Tray H850 x W1050 x D430mm	£394.00
SRS-489	38 Tray H1830 x W710 x D430mm	£484.00
SRS-490	45 Tray H1510 x W1050 x D430mm	£559.00
SRS-491	57 Tray H1830 x W1050 x D430mm	£672.00



Monarch Wooden Storage

High quality Bookcases and Cupboards



Cupboards from only **£245.00**

A range of high quality of Bookcases and Cupboards available in Beech or Maple.

All cupboards feature adjustable shelves and locking doors.

Bookcases feature adjustable shelves which are 300mm deep making them ideal for books, ring binders and box files.

Delivered fully assembled.

Order Code	Description	Price
SRS-546	H1800 x W1030 x D477mm	£320.00
SRS-547	H1500 x W1030 x D477mm	£300.00
SRS-588	H1250 x W1030 x D477mm	£275.00
SRS-589	H1000 x W1030 x D477mm	£255.00
SRS-2590	H750 x W1030 x D320mm	£245.00

Bookcases from only **£135.00**

Order Code	Description	Price
SRS-542	H1800 x W900 x D320mm	£180.00
SRS-543	H1500 x W900 x D320mm	£165.00
SRS-544	H1250 x W900 x D320mm	£155.00
SRS-545	H1000 x W900 x D320mm	£145.00
SRS-2546	H750 x W900 x D320mm	£135.00



Wood Finishes



0845 6033 606



sales@schoolsrus.co.uk

77

ISO Seating

An incredibly popular range of seating



**ISO
Chair**



**ISO
Wood**



**ISO
Chrome**

Optional Extras



Arms (Pair)
£17.50

Order Code: SRS-565



Plastic Writing Tablet
£27.75

Order Code: SRS-566



**Plastic Writing Tablet
and Arms**
£29.95

Order Code: SRS-567

An incredibly popular choice of seating.
Wide range of optional extras to suit
any user requirement.

Stacks 8 high when not in use.

The ISO Chair is available from stock
in 6 colours.

The ISO Wood Chair comes in Beech as standard.

The ISO Chrome Chair is available in 4 colours.

Order Code	Description	Price
SRS-562	ISO Chair	£29.95
SRS-563	ISO Wood Chair	£32.95
SRS-564	ISO Chrome Chair	£52.00



ISO Fabric Colours



* Denotes only available with Black frame



Maestro Chairs

High density stacking chairs for a variety of purposes



A contemporary and comfortable high density stacking chair for large areas of seating, dining rooms and social facilities.

Superior durability, meeting with BIFMA industry standards. Stacks up to 10 high freestanding, or up to an impressive 38 high using the Maestro Chair Dolly.

Black, Flannel and Nordic are stocked. On other colours, please allow up to 5 weeks for delivery.

Order Code	Description	Price
SRS-550	Maestro Chairs	£83.90
SRS-551	Maestro Chair Writing Tablet	£67.00
SRS-552	38 Capacity Maestro Chair Dolly	£240.00

Colours Available

Black	
Chocolate	
Misty Brown	
Flannel	
Blue Grey	
Warm Grey	
Cool Grey	
Sand	
Light Tone	
Wet Sand	
Cottonwood	
Nordic	
Ultra Blue	
Sky Blue	
Splash	
Surf's Up	
Grass Green	
Zesty Lime	
Rubber Ducky	
Nemo	
Cayenne	
Poppy Red	
Mardi Gras	
Purple Haze	



0845 6033 606



sales@schoolsrus.co.uk

79

Reception Chairs

Featuring super strong steel frames

Extra Heavy Duty Low Easy Seating



British built and manufactured, these chairs look fantastic in any reception area or common room area within schools. **Frame Choice**

Incredibly comfortable with extra thick foam seats.

Black

Light Grey

Extra strong sturdy metal frames.

Order Code	Description	Price
SRS-581	Extra Heavy Duty Chair H840 x W530mm	£117.00
SRS-582	Extra Heavy Duty Armchair H840 x W560mm	£149.50
SRS-583	Coffee Table H340 x W600 x D600mm	£75.00

All Chairs D610mm. Seat Dimensions: H410 x W510 x D510mm.



For fabric options:
www.camirafabrics.com/en-uk/contract/fabrics/advantage

SRS-583



Reception Chairs

Featuring super strong steel frames

D Series Reception Seating

Manufactured with durable 25mm steel coated in epoxy powder. Deep padded seat offering exceptional user comfort.

A fantastic choice for school reception areas, libraries and sixth form common rooms.



D7 Reception Chair



D9 Reception Chair



For fabric options:
www.camirafabrics.com/en-uk/contract/fabrics/advantage

Frame Choice

Black

Light Grey

Order Code	Description	Price
SRS-576	D7 Reception Chair No Arms H750 x W520mm	£89.00
SRS-577	D7 Reception Chair With Arms H750 x W570mm	£129.00
SRS-578	D9 Reception Chair Skidbase H750 x W520mm	£112.00
SRS-579	Coffee Table - H340 x W600 x D600mm	£67.00
SRS-580	Large Coffee Table - H340 x W1200 x D600mm	£80.00

All Chairs D580mm. Seat Dimensions: H420 x W520 x D460mm



0845 6033 606



sales@schoolsrus.co.uk

81

Faux Leather Tub Seating

Available in a choice of vibrant colours

A stunning range of Faux Leather Tub Seating available in a range of vibrant colours with sturdy metal feet.

Available in 6 colours.

Upholstered in wipe clean PU faux leather.

Perfect for use in libraries and reception areas within schools.



Order Code	Description (Seat Dimensions)	Price
SRS-599	Tub Chair H430 x D515 x W515mm	£240.00
SRS-600	Tub Sofa H420 x D500 x W1020mm	£429.00



Aqua Blue



Red



Orange



Lime



Black



Blue



Glacier Modular Seating

Perfect for reception areas, libraries and more



Fully upholstered reception seating perfect for use in school reception areas, staff rooms, libraries and sixth form common rooms.

Deep foam padded seat and back with black plastic feet.

Arms are available to purchase separately.

Order Code	Description	Price
SRS-2205	Chair W610 x D670 x H830mm	£145.00
SRS-2206	Glacier Table W630 x D630 x H350mm	£95.00
SRS-2207	Single Arm W660 x D100 x H630mm	£42.50
SRS-2208	Pair of Arms	£95.00

Blue

Charcoal



0845 6033 606



sales@schoolsrus.co.uk

83

Reception Chairs

Featuring super strong steel frames

Jade Reception Chair

A contemporary reception chair offering an exceptional level of user comfort thanks to its deep seat and back.

Black industrial style steel frame.

W600 x D540 x H435mm.

£149.00

Order Code: SRS-2209



Pearl Reception Chair

The Pearl Reception Chair offers exceptional user comfort. It is perfect for use in school libraries, reception areas and staffrooms.

Black industrial style steel frame.

W650 x D800 x H860mm.

£179.00

Order Code: SRS-2211



Fabric Choice



Reception Chairs

Please note these products are sold in sets of 2



4 Legged Reception Chair

Stunning contemporary design available in 4 colours.

Boxed and sold in sets of 2.

Seat height 470mm.

Limited assembly required.

Soft brushed fabric with modern oak legs.



£180.00

Order Code: SRS-2368
(£90.00 per chair)

Welcome Reception Chair

Contemporary reception chair available in 2 colours.

Boxed and sold in sets of 2.

Seat height 500mm.

Limited assembly required.

Soft brushed fabric with modern oak legs.

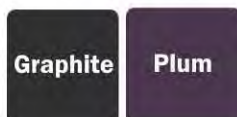

£198.00

Order Code: SRS-2367
(£99.00 per chair)



4 Legged Reception Chair PU

Contemporary reception chair with an easy to maintain, wipe clean finish.

Modern oak legs.

Boxed and sold in sets of 2.

Seat height 470mm.

Limited assembly required.

£198.00

Order Code: SRS-2369
(£99.00 per chair)



0845 6033 606



sales@schoolsrus.co.uk

85

Task / Operator Chairs

Perfect for school offices

Java 200 High Back Operator Chairs

A high back operator chair featuring a posture curved seat with waterfall front. Sculptured lumbar and spine support. Back tilt adjustment. Back height adjustment. Black nylon base with twin wheel hooded castors. Certified to BS EN 1335 level 3.



Blue



SRS-SFA
Shark Fin Style
Hoop Arms

£22.50



SRS-TAA
T Section
Adjustable Arms

£35.00

£64.00

Order Code: SRS-637



Red



Charcoal



Green



Black

Java 300 High Back Operator Chairs

High back synchronised operator chair featuring a posture curved seat with waterfall front. Fitted with an under-seat skirt. Sculptured lumbar and spine support. Back tilt adjustment. Independent seat tilt. Back height adjustment. Black nylon base fitted with twin wheel hooded castors. Certified to BS EN 1335 Level 3.



SRS-SFA
Shark Fin Style

Hoop Arms

£22.50



SRS-TAA
T Section

Adjustable Arms

£35.00

£75.00

Order Code: SRS-638



Red



Blue



Charcoal



Green



Black



Task / Operator Chairs

Perfect for school offices

Luna Plus 2 Operator Chair

The Luna Plus 2 Operator Chair offers fantastic value for money.

Black

Blue

Charcoal

Permanent contact backrest tilt angle adjustment. Height adjustable backrest.

Gas lift seat height adjustment.

Tested to ANSI/BIFMA X 5.1-2017 strength & endurance standards

Order Code	Description	Price
SRS-2449	Luna Plus 2 Operator	£59.95
SRS-2550	Luna Plus 2 + Hoop Arms	£69.95
SRS-2551	Luna Plus 2 + Adjustable Arms	£75.00



Thames 24 Hour High Back Operator Chair

High contoured shaped backrest with 3D curvature incorporating lumbar and spine support.

Multi-set mechanism for gas seat height, backrest rake, forward seat tilt and seat slide.

Multi-directional and height adjustable arms.

Large black nylon base fitted with twin hooded castors. Designed for 24 hour use.

£170.00

Order Code: SRS-634



Choose from Black, Blue or Wine fabric finish.



0845 6033 606



sales@schoolsrus.co.uk

87

Task / Operator Chairs

Perfect for school offices



Calypso II Budget Operator Chair

High quality office chair with a budget friendly price tag. Fully upholstered seat and back.

Weight capacity: 118kg.
Easy self assembly.

£69.95

Order Code: SRS-2095

Black

Blue

Charcoal

Call Centre 24 Hour Operator Chair

Designed for intensive, 24 hour usage. Enhances user comfort with a thick, moulded back and 2D adjustable arms included. Heavy duty gas lift rated to 152kg with asynchro movements, allowing the chair to adapt to all of the user's weight.

Physio-approved.

£210.00

Order Code: SRS-2093

Black

Blue

Charcoal



Marlos Mesh Operator Chair

Cost effective task chair with stylish folding arms. Light and breathable mesh back.

Weight capacity 115kg.

Perfect for pupils and staff.

Featuring a lock-tilt mechanism with torsion control, allowing the user to choose whether to sit at a fixed tilt angle or float freely.

£89.95

Order Code: SRS-2204

Black

Blue

Green

Red

Orange



Edge Chairs

High density stacking chairs for the school hall

Edge Chairs are a fantastic choice for school halls.

These high quality chairs stack 10 high freestanding or 30 high on their trolley.

470mm seat height with a strong, solid steel frame.



Order Code	Description	Price
SRS-2431	Edge Chair	£65.00
SRS-2432	Edge Chair Trolley	£220.00

Chair Colours

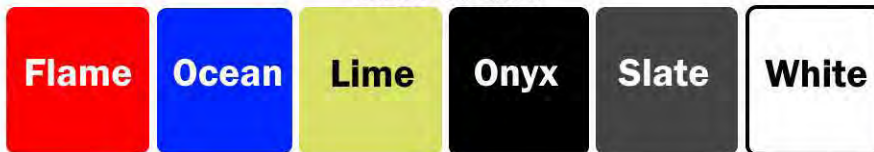

Choice of Frame



Start Office Furniture

Can be mixed and matched to use 3+ pricing

Our Start range of office furniture offers fantastic value for money without compromising quality.

Start Office Desks are available in 3 wood finishes, with a choice of 2 frame colours, and a choice of Rectangular or Crescent desks.

1400mm Rectangular Desk,
Beech, Silver frame



1800mm Crescent Desk, Oak, White Frame

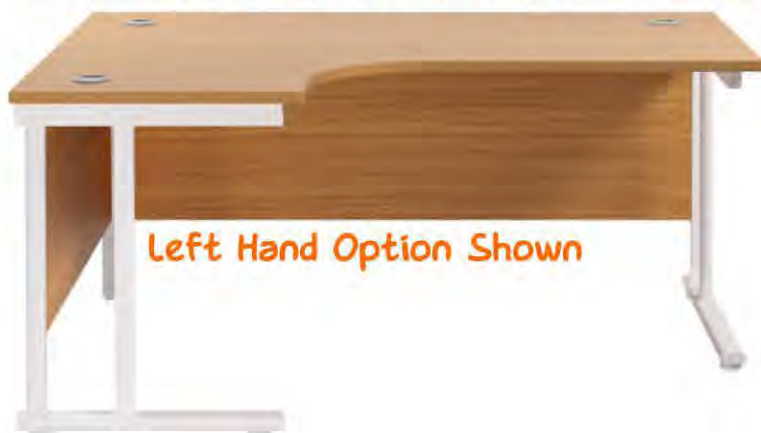

Left Hand Option Shown

25mm thick desk tops. FSC certified.

Includes all metal to metal fixings for easy self assembly.

Order Code	Description	1-2	3+
SRS-2096	W1200mm Rectangular Desk	£140.00	£130.00
SRS-2097	W1400mm Rectangular Desk	£155.00	£145.00
SRS-2098	W1600mm Rectangular Desk	£160.00	£150.00
SRS-2099	W1800mm Rectangular Desk	£170.00	£160.00
SRS-2100	W1600mm Crescent Desk	£198.00	£188.00
SRS-2101	W1800mm Crescent Desk	£225.00	£215.00

Wood Finishes



Frame Colours



Start Office Furniture

Can be mixed and matched to use 3+ pricing

Start Bookcases / Cupboards

Part of our Start range of office furniture. One piece MFC back panel. FSC certified. Cupboards have lockable doors. W800 x D450mm.



Bookcases

Cupboards

Order Code	Description	1-2	3+
SRS-2102	H730mm 1 Shelf	£110.00	£100.00
SRS-2103	H1200mm 2 Shelves	£145.00	£135.00
SRS-2104	H1800mm 3 Shelves	£180.00	£170.00
SRS-2105	H2000mm 4 Shelves	£190.00	£180.00

Order Code	Description	1-2	3+
SRS-2106	H730mm 1 Shelf	£130.00	£120.00
SRS-2107	H1200mm 2 Shelves	£180.00	£170.00
SRS-2108	H1800mm 3 Shelves	£230.00	£220.00
SRS-2109	H2000mm 4 Shelves	£240.00	£230.00

Start Filing Cabinets

Part of our Start range of office furniture. A4 and A5 suspension filing. 600mm wide. Anti-tilt with 100% drawer extension.

Order Code	Description	1-2	3+
SRS-2110	H710mm 2 Drawer	£160.00	£150.00
SRS-2111	H1390mm 4 Drawer	£215.00	£205.00
SRS-2360	H1055mm 3 Drawer	£187.00	£177.00



Start Desk Pedestals

Part of our Start range of office furniture. A4 and A5 suspension filing. 404mm wide. Anti-tilt with 100% drawer extension.

Order Code	Description	1-2	3+
SRS-2112	Desk High, 3 Drawer D600mm	£127.00	£117.00
SRS-2113	Desk High, 3 Drawer D800mm	£155.00	£145.00
SRS-2114	Mobile, 2 Drawer	£110.00	£100.00
SRS-2115	Mobile, 3 Drawer	£110.00	£100.00
SRS-2116	Under Desk, 3 Drawer	£136.00	£126.00



Wood Finishes



0845 6033 606



sales@schoolsrus.co.uk

91

Core Office Furniture

Can be mixed and matched to use 3+ pricing

Core Office Desks offer fantastic value for money without compromising quality. Available in 3 wood finishes.



Rectangular Desks
available either 600mm
or 800mm deep

Order Code	Description	1-2	3+
SRS-2471	800x600mm Desk	£91.00	£81.00
SRS-2472	1200x600mm Desk	£105.00	£95.00
SRS-2473	1400x600mm Desk	£108.00	£98.00
SRS-2474	1600x600mm Desk	£113.00	£103.00
SRS-2475	1800x600mm Desk	£118.00	£108.00
SRS-2476	800x800mm Desk	£99.00	£89.00
SRS-2477	1200x800mm Desk	£107.00	£97.00
SRS-2478	1400x800mm Desk	£112.00	£102.00
SRS-2479	1600x800mm Desk	£115.00	£105.00
SRS-2480	1800x800mm Desk	£122.00	£112.00



Order Code	Description	1-2	3+
SRS-2481	1600mm Crescent Left Hand Desk	£137.00	£127.00
SRS-2482	1600mm Crescent Right Hand Desk	£137.00	£127.00
SRS-2483	1800mm Crescent Left Hand Desk	£147.00	£137.00
SRS-2484	1800mm Crescent Right Hand Desk	£147.00	£137.00

Wood Finishes



Frame Colours



Core Office Furniture

Can be mixed and matched to use 3+ pricing

Core Bookcases and Cupboards

Floating shelves included.

Cupboards are lockable.

Bookcases		1-2	3+
SRS-2485	730mm 1 Shelf	£95.00	£85.00
SRS-2486	816mm 1 Shelf	£100.00	£90.00
SRS-2487	1200mm 2 Shelf	£110.00	£100.00
SRS-2488	1600mm 3 Shelf	£115.00	£105.00
SRS-2489	1980mm 4 Shelf	£125.00	£115.00
Cupboards			
SRS-2490	730mm 1 Shelf	£112.00	£102.00
SRS-2491	816mm 1 Shelf	£114.00	£104.00
SRS-2492	1200mm 2 Shelf	£128.00	£118.00
SRS-2493	1600mm 3 Shelf	£133.00	£123.00
SRS-2494	1980mm 4 Shelf	£157.00	£147.00



Wood Finishes

Beech

Oak

White



Core Filing Cabinets

Locking filing cabinets available in two heights.



Order Code	Description	1-2	3+
SRS-2495	2 Drawer H707mm	£130.00	£120.00
SRS-2496	4 Drawer H1358mm	£170.00	£160.00

Wood Finishes

Beech

Oak

White

Core Desk Pedestals

Locking desk pedestals.

Choice of Desk High or Mobile.

Wood Finishes

Beech

Oak

White

Order Code	Description	1-2	3+
SRS-2497	Desk High - D600mm	£105.00	£95.00
SRS-2498	Desk High - D800mm	£118.00	£108.00
SRS-2499	Mobile Pedestal 2 Drawer	£90.00	£80.00
SRS-2500	Mobile Pedestal 3 Drawer	£90.00	£80.00



0845 6033 606



sales@schoolsrus.co.uk

93

Start Office Furniture

Can be mixed and matched to use 3+ pricing

Start Steel Cupboards

Delivered fully assembled and ready to use with shelves.
920mm wide and 420mm deep.
50kg weight capacity.
A4 suspension filing.

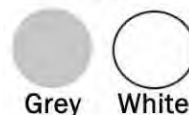

Order Code	Description	1-2	3+
SRS-2117	H1000mm 2 Shelves	£165.00	£155.00
SRS-2118	H1790mm 4 Shelves	£202.00	£192.00
SRS-2119	H1950mm 4 Shelves	£260.00	£250.00
SRS-2120	Additional Shelf	£16.00	£16.00

Start Filing Cabinets

High quality filing cabinets at minimal expense.
Integral locking.
Anti-tilt mechanism.
A4 and FS suspension filing.
100% drawer extension.
40kg loading capacity.
465mm wide and 620mm deep.



Order Code	Description	1-2	3+
SRS-2121	H700mm 2 Drawers	£140.00	£130.00
SRS-2122	H1000mm 3 Drawers	£150.00	£140.00
SRS-2123	H1300mm 4 Drawers	£167.00	£157.00

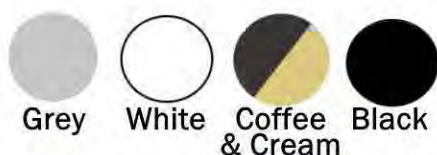

Start Office Furniture

Can be mixed and matched to use 3+ pricing



Start Office Tambours are the ideal storage solution for your office.

Delivered fully assembled and ready to use.

A flexible alternative to wooden storage.

Lockable side-opening shutter doors.

Can incorporate a mix of flat shelves and suspension frames.

Order Code	Description	1-2 Units	3+
SRS-2124	2 Shelves H1050 x W1000mm	£285.00	£275.00
SRS-2125	4 Shelves H1950 x W1000mm	£330.00	£320.00
SRS-2126	Black Filing Frame	£79.00	£79.00
SRS-2127	Additional Steel Shelf	£17.00	£17.00

Metal Finishes



Grey



White



0845 6033 606



sales@schoolsrus.co.uk

95

Metal Storage Furniture

Offering exceptional value for money

Contract Filing Cabinets

The improved Kontrax range of filing cabinets is an incredibly popular choice of office and classroom storage.

Anti-tilt mechanism.

30kg suspension file capacity per drawer.

Band 1 colours delivered from stock.



For colour options, please see the next page

Order Code	Description	Band 1	Band 2	Band 3
SRS-745	2 Drawer - W458 x D622 x H711mm	£125.00	£133.00	£150.00
SRS-746	3 Drawer - W458 x D622 x H1009mm	£135.00	£143.00	£160.00
SRS-747	4 Drawer - W458 x D622 x H1320mm	£140.00	£148.00	£165.00

Executive Filing Cabinets

Manufactured using sustainably sourced steel that shows a significantly reduced carbon footprint.

Anti-tilt mechanism.

30kg suspension file capacity per drawer.

Band 1 colours delivered from stock.



For colour options, please see the next page

Order Code	Description	Band 1	Band 2	Band 3
SRS-748	2 Drawer - W458 x D622 x H711mm	£135.00	£143.00	£161.00
SRS-749	3 Drawer - W458 x D622 x H1009mm	£142.00	£150.00	£168.00
SRS-750	4 Drawer - W458 x D622 x H1320mm	£147.50	£155.50	£173.50



Metal Storage Furniture

Offering exceptional value for money

Kontrax Metal Cupboards

Kontrax Cupboards offer an economic solution to storage requirements.

Fira certified.

Two key mastered series.

Full length door stiffness.

Band 1 colours are delivered from stock.

5
YEARS
Guarantee



Order Code	Description	Band 1	Band 2	Band 3
SRS-751	1 Shelf - W915 x D458 x H1020mm	£169.00	£179.00	£209.00
SRS-752	2 Shelf - W915 x D458 x H1650mm	£219.50	£229.50	£259.50
SRS-753	3 Shelf - W915 x D458 x H1830mm	£229.50	£239.50	£269.50
SRS-754	4 Shelf - W915 x D458 x H1950mm	£290.00	£300.00	£333.00

BAND 1

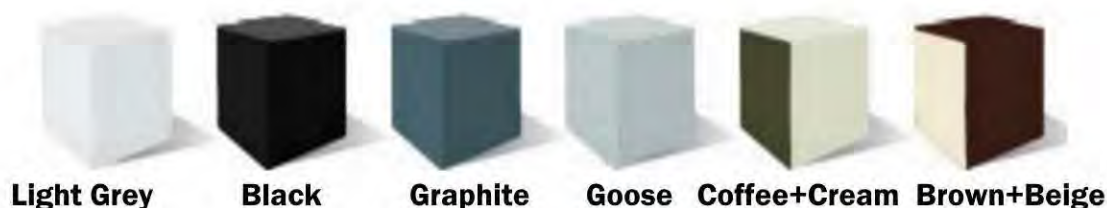

BAND 2



BAND 3



0845 6033 606



sales@schoolsrus.co.uk

97

Visual Aids

At incredibly low prices from Schoolsrus

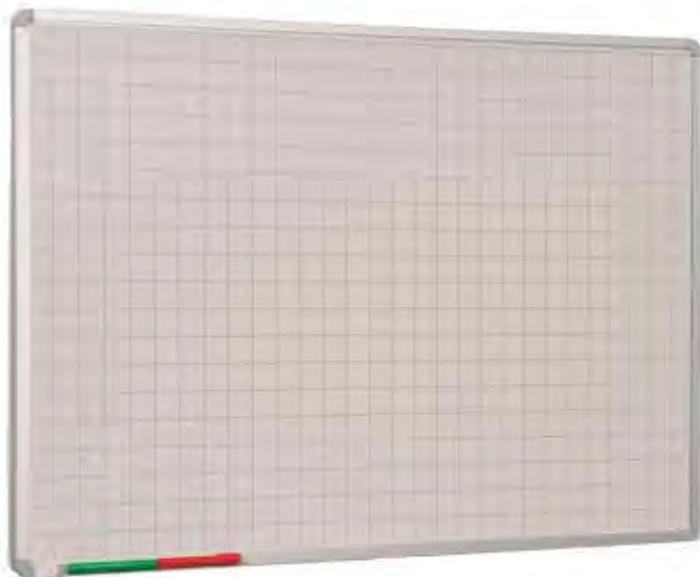

Non-Magnetic Drymaster Writing Boards

Double value Drymaster whiteboards with satin silver anodised aluminium frames. Rounded safety corners and concealed corner fixing. Plain one side reverse with discreet 25mm grid guide. Pen ledge and wall fixings are included.

5 Year Surface Guarantee.

Order Code	Description	Price
SRS-812	W900 x H600mm	£28.95
SRS-813	W1200 x H900mm	£43.95
SRS-814	W1200 x H1200mm	£53.80
SRS-815	W1500 x H1200mm	£61.20
SRS-816	W1800 x H1200mm	£76.70
SRS-817	W2400 x H1200mm	£99.10



Magnetic Writing Boards

Coated steel is a less costly alternative to Vitreous Enamel Steel boards. Magnetic drywipe single sided whiteboard surface with satin silver anodised aluminium frame.

Rounded safety corners and concealed corner fixing. Pen ledge and wall fixings included.

5 Year Surface Guarantee.

Order Code	Description	Price
SRS-818	W900 x H600mm	£29.55
SRS-819	W1200 x H900mm	£51.55
SRS-820	W1200 x H1200mm	£69.80
SRS-821	W1500 x H1200mm	£80.15
SRS-822	W1800 x H1200mm	£92.05
SRS-823	W2400 x H1200mm	£119.30



Visual Aids

At incredibly low prices from Schoolsrus

Chalk Writing Boards

Non-reflective, non-magnetic chalk board with satin anodised aluminium frame.

Rounded safety corners and concealed corner fixing.

Chalk ledge and wall fixings are included.



Order Code	Description	Price
SRS-824	W900 x H600mm	£48.95
SRS-825	W1200 x H900mm	£78.85
SRS-826	W1200 x H1200mm	£88.45
SRS-827	W1500 x H1200mm	£91.90
SRS-828	W1800 x H1200mm	£101.85
SRS-829	W2400 x H1200mm	£117.95

Vitreous Enamel Steel Writing Boards

These whiteboards offer the ultimate drywipe surface. Satin silver anodised aluminium frames with rounded corners and concealed corner fixing. Free from pen ghosting with this quality of board surface when using recommended pens. Pen ledge and wall fixings are included. Also available as a VES Projection whiteboard.

25 Year Guarantee.



VES Writing Board

Order Code	Description	Price
SRS-830	W900 x H600mm	£51.50
SRS-831	W1200 x H900mm	£80.00
SRS-832	W1200 x H1200mm	£99.95
SRS-833	W1500 x H1200mm	£125.00
SRS-834	W1800 x H1200mm	£137.50
SRS-835	W2400 x H1200mm	£180.00

VES Projection Writing Board

Order Code	Description	Price
SRS-838	W1200 x H1200mm	£163.85
SRS-839	W1500 x H1200mm	£208.70
SRS-840	W1800 x H1200mm	£253.60
SRS-841	W2400 x H1200mm	£296.10



0845 6033 606



sales@schoolsrus.co.uk

99

Visual Aids

At incredibly low prices from Schoolsrus



Decorative Aluminium Framed Noticeboards

Anodised aluminium frame with rounded safety corners. Concealed corner fixings with snap-on cover.

9.5mm core material.

Fire rated felt cover for pins.

Can be fixed either portrait or landscape. Wall fixings are included.

Felt Colours



Order Code	Description	Price
SRS-908	W900 x H600mm	£30.95
SRS-909	W1200 x H900mm	£42.60
SRS-910	W1200 x H1200mm	£50.85
SRS-911	W1500 x H1200mm	£63.05
SRS-912	W1800 x H1200mm	£72.25
SRS-913	W2400 x H1200mm	£88.35

Decorative Wood Framed Noticeboards



Felt Colours



Traditional, pine wood frames with mitred corners. Light Oak or Light Beech finishes. Fire rated felt finish suitable for pins. Traditional brass plated fittings included.

Order Code	Description	Price
SRS-914	W900 x H600mm	£40.00
SRS-915	W1200 x H900mm	£48.50
SRS-916	W1200 x H1200mm	£58.25
SRS-917	W1500 x H1200mm	£67.50
SRS-918	W1800 x H1200mm	£73.00
SRS-919	W2400 x H1200mm	£90.00



Visual Aids

At incredibly low prices from Schoolsrus



Lockable Glazed Tamperproof Noticeboards

Fire rated felt finish suitable for pins. Locking, hinged polycarbonate doors, or double doors on the largest sizes. Satin silver anodised aluminium frames with rounded corners. Single door models can be fixed either portrait or landscape and the door is hinged to the long edge. Twin door models can ONLY be fitted landscape. Wall fixings included.



Order Code	Description	Price
SRS-920	W900 x H600mm	£77.50
SRS-921	W1200 x H900mm	£109.50
SRS-922	W1200 x H1200mm	£138.45
SRS-923	W1800 x H1200mm	£217.75
SRS-924	W2400 x H1200mm	£262.75



0845 6033 606



sales@schoolsrus.co.uk

101

Picnic Tables

At incredibly low prices from Schoolsrus

Hereford Picnic Table

These hardwearing outdoor picnic tables are made from solid spruce wood and are easy to assemble.



Available in 2 sizes - 6 seater (W1400 x D1280 x H680mm) or 8 seater (W1800 x D1280 x H680mm)

Order Code	Description	Price
SRS-2452	6 Seater	£155.00
SRS-2453	8 Seater	£185.00

King Picnic Table



This easy to assemble picnic bench is made from timber and designed to withstand years of use.

Dimensions: W1800 x D1800 x H680mm

£305.00

Order Code: SRS-2454

Winer Diner Picnic Table



The Winer Diner six seater picnic bench is manufactured from sturdy pine with a 60mm thick top.

Dimensions: W1360 x D1360 x H735mm

£269.00

Order Code: SRS-2455

Litter Bins

At incredibly low prices from Schoolsrus

Slimline Classic Litter Bins

Our Slimline Classic Litter Bins are available with either Tidy Man or Litter logos as pictured.

These 52L capacity bins are suitable for indoor and outdoor use.

Please specify whether you require plastic or galvanised steel liners.



Tidy Man Logo

£204.00

Order Code: SRS-2456

Litter Logo

£215.00

Order Code: SRS-2457



Classic Litter Bins

Our Classic Litter Bins are available with either a Tidy Man logo as pictured, or plain.

90L capacity bin for indoor and outdoor use. Please specify whether you require plastic or galvanised steel liners.



Tidy Man Logo

£244.00

Order Code: SRS-2458

Plain

£244.00

Order Code: SRS-2459



0845 6033 606



sales@schoolsrus.co.uk

103

Schoolsrus

School Furniture Catalogue 2024/25

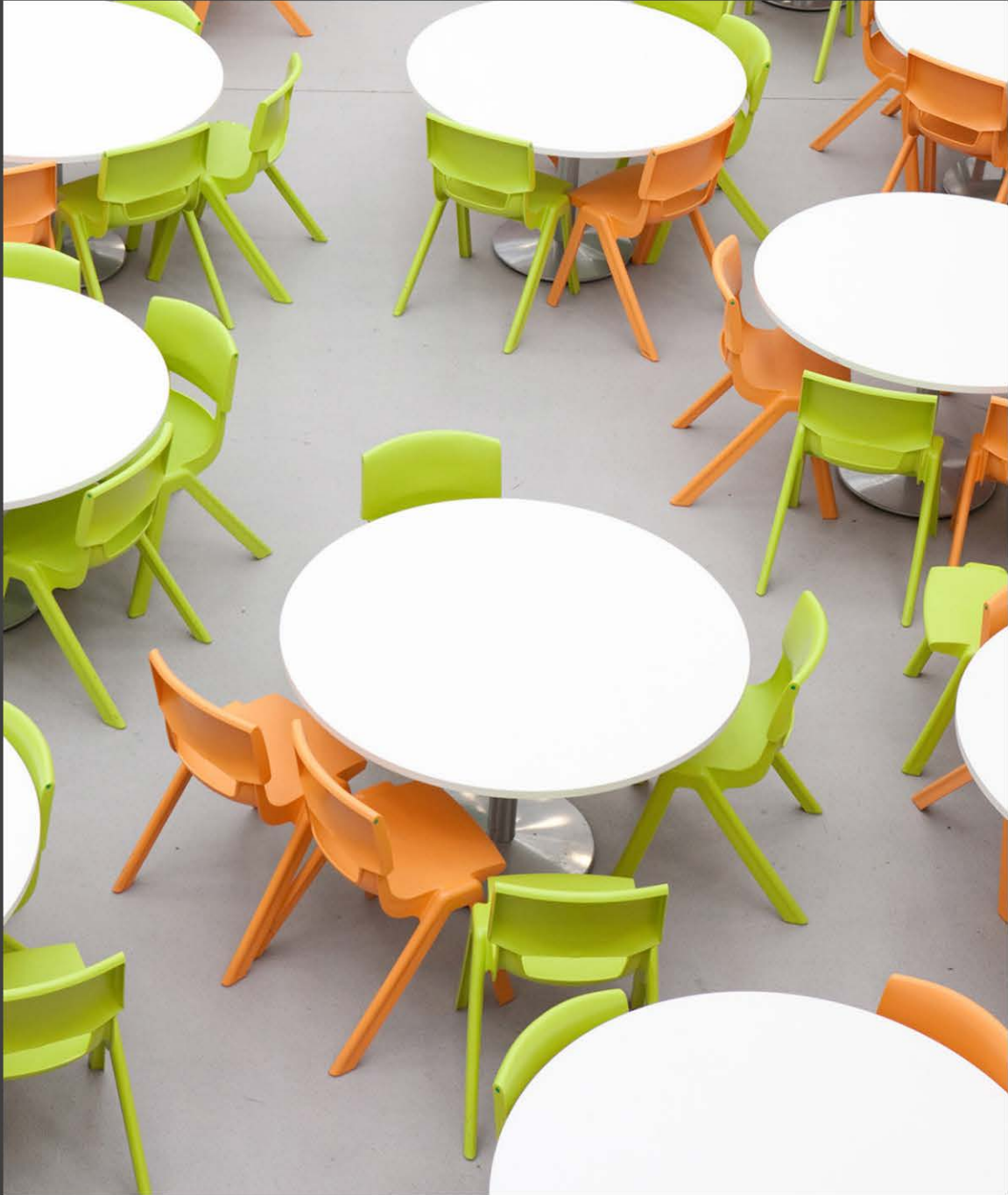

Schoolsrus, Wereham House, Parker's Cross,
Looe, Cornwall, PL13 2NF



sales@schoolsrus.co.uk



0845 6033 606



www.schoolsrus.co.uk